

USER'S MANUAL

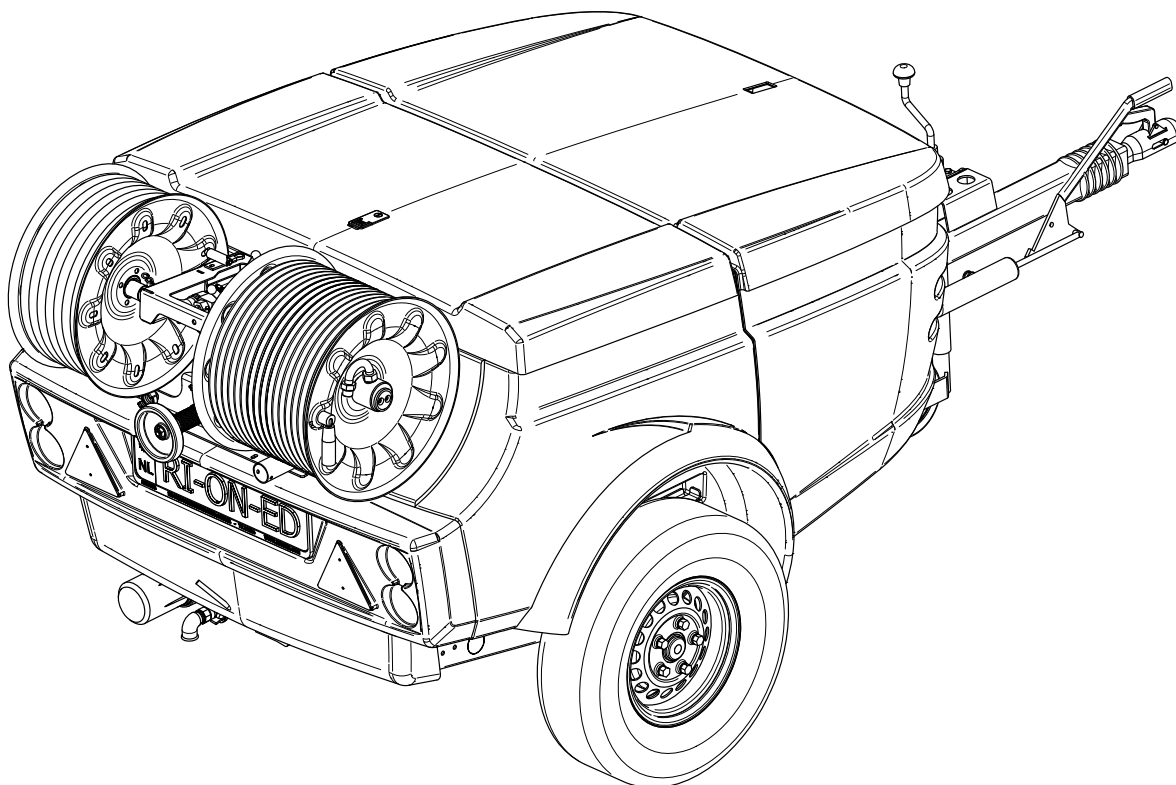

Edition: 08
Date: Wednesday 24 January 2018

RIONED
P.O. Box 5070
5004 EB Tilburg
The Netherlands
Telephone: +31 13 5479100
e-mail: info@rioned.com
Internet: www.rioned.com

© Copyright 01/18 Rioned/Rior B.V.Tilburg - Netherlands

All rights reserved. No part of this publication may be copied or published by means of printing, photocopying, microfilm or otherwise without the prior written consent of **RIONED**. This restriction also holds for the corresponding drawings and diagrams.

RIONED has the right to change parts at any time without any prior or direct warning to the client. Also, the contents of this manual can be changed without any prior warning.

This manual is to be used only for this machine.

For extra information on adjustments, maintenance and repair, please contact the technical department of your dealer.

Foreword

This user's manual is a manual for the professional user.

This user's manual has the purpose to control the machine in a safety manner and must be saved with the machine.

The photos and drawings help you understand the text easier.

First the user's manual gives you an overview of the most important safety aspects. Then we explain how the machine is built up and the global working of the machine. Chapter "Technical specifications" gives you information about the working characteristics, performance under normal use and construction specifications.

"Control" is the next chapter. This chapter explains how to use the machine systematically.

In the chapter "Maintenance", the user can do small maintenance on the machine.

Chapter "Trouble shooting" has the purpose to solve simple defects.

With the "Exploded views" you can order original spare parts, are also useful for mounting, and disassemble the machine.

Finally gives the chapter "Appendix" information about electrical and/or hydraulic

TABLE OF CONTENTS

1	INTRODUCTION.....	3
	1.1 Use.....	3
2	SECURITY.....	5
	2.1 Instruction indications in this manual.....	5
	2.2 Descriptions security measures.....	5
	2.3 Personnel protection outfit.....	5
	2.4 Warnings.....	6
	2.5 Personnel qualification and education.....	6
	2.6 Danger that can occur if the security regulations aren't observed.....	6
	2.7 Working safely.....	6
	2.8 Security regulations for the user and technical service.....	6
	2.9 Security regulations for maintenance, inspection and mounting activities.....	7
	2.10 Making changes and fabricate spare parts.....	7
	2.11 Improper use.....	7
3	TECHNICAL SPECIFICATION.....	9
	3.1 General.....	9
	3.2 Engine.....	10
	3.3 Pump.....	11
4	CONSTRUCTION.....	13
5	CONTROL.....	17
	5.1 Hitching up the trailer.....	17
	5.2 Check before departure.....	18
	5.3 Unhitching and setting up.....	18
	5.4 Control box.....	19
	5.5 Radio remote control.....	19
	5.6 Before starting.....	19
	5.7 Starting the machine.....	20
	5.8 Unclogging a drain.....	26
	5.9 Stop spraying:.....	28
	5.10 Cleaning a wall, terrace or floor.....	29
	5.11 Spray with spray lance.....	31
	5.12 Stop the engine.....	33
	5.13 Ending duties.....	34
	5.14 Using the device during periods of frost.....	34
	5.15 Additional preparations when preparing for use:.....	35
6	SYMBOLS.....	37
	6.1 Control box.....	37
	6.2 Pressure gauge.....	39
	6.3 Pressure regulator.....	39
	6.4 Security sticker.....	40
7	OPTIONS.....	41
	7.1 Hydraulic reel control.....	41

7.2	Hose guide	41
7.3	Hour counter	42
7.4	Run dry protection	42
7.5	Water level control	42
7.6	Suction Ventury	43
7.7	2e HP-reel instead of supply reel	44
7.8	Check valve in supply pipe	44
7.9	License Plate Holders	44
7.10	Working lamp	44
7.11	Warning beacon	44
7.12	Pulsator system	45
7.13	Radio remote control	45
7.14	Radio remote control (Flexmote)	47
7.15	Water circuit circulate	48
8	MAINTENANCE	51
8.1	Daily maintenance	51
8.2	Weekly maintenance	51
8.3	Minor servicing	51
8.4	Maintenance wheel bearings and wheel nuts	52
8.5	Check the brake drums and the brakes	52
8.6	Replacing lamps in the lighting unit	53
8.7	Maintenance remote control	54
8.8	Hydraulic system	54
8.9	Extensive periodical maintenance	55
8.10	Maintenance scheme	56
9	TROUBLESHOOTING	57
10	AUXILIARIES	61
11	APPENDIX	63
11.1	EC declaration Of Conformity For Machinery	63
11.2	Contact sales representatives	64
11.3	After Sales Service	64
11.4	Dimension FlexJet	65
11.5	Dimension FlexJet+	66
11.6 Sound level report FlexJet	67
11.7	Sound level report FlexJet+	68
11.8	COC	69
12	INDEX	73

1 INTRODUCTION

RIONED wishes to thank you for your purchase of the RIONED drain and sewer-clearing machine. We recommend that you read this manual thoroughly and see that the machine is handled and maintained in the proper manner. If your machine should give trouble and need servicing, when you want to order parts, or if you have any questions, contact your RIONED dealer.

The machine is built by:

RIONED

P.O. Box 5070

5004 EB Tilburg

The Netherlands

Telephone: +31 13 5479100

e-mail: info@rioned.com

Internet: www.rioned.com

The Rioned high-pressure device has been especially designed and manufactured for cleaning drains, walls, floors and terraces with cold or hot water. For cleaning drains, special nozzles are included in the delivery; for all other purposes, the spray-gun which is also included, can be used.

This manual contains all the necessary information concerning control and maintenance. If the device is positioned correctly, properly controlled, and regularly maintained, a warranty will be given according to the general conditions of delivery. However, should it arise that the control and maintenance procedures are not diligently followed, the warranty will become invalid.

The machine may only be used by authorized personnel.

The machine can not be used in an explosive environment.

In this manual you will find all necessary information concerning operations and maintaining your machine. If handled properly, your machine is guaranteed according the general delivery conditions.

1.1

Use

The integrated engine drives the high-pressure pump via a V-belt. This pump receives water from the water tank via the water filter and pressurizes it. The pressure can be continuously adjusted. The pressurized water leaves the machine via the high-pressure hose on the reel.

2 SECURITY

Be responsible for other people when you are working with this machine.

This manual contains instructions for fundamental conditions that must be followed by use and maintenance of this machine.

That is why it is necessary that authorised and qualified personnel must read the user's manual and the user's manual must always be available with the machine. Near the general regulations in this chapter, you must also follow the security regulations in the other chapters.

2.1 Instruction indications in this manual

The in this manual containing security instructions, which are dangerous if they are not obeyed, are marked with general security signs.



Security sign DIN 4844-W9.

2.2 Descriptions security measures

- *Emergency stop*

This machine is equipped with an emergency stop. By operating the emergency stop, the machine will stop immediately. Do not use this button for normal stopping. Only use it when dangerous situations occur. After use, remove the danger and pull the emergency stop in order to be able to start up again. Make sure the emergency stop can always be reached.

- *Pressure regulator*

The pressure regulator ensures that the pressure never gets too high and thus acts as a safety valve.

- *Security covers*

This machine is equipped with several security covers over parts that are rotating. It is forbidden to remove these security covers during operating this machine. You can only remove them if there is maintenance on the machine. Stop the machine.

2.3 Personnel protection outfit

- *Protection looking glasses*
- *Ear protector (recommended)*
- *Gloves (recommended)*
- *Water tight clothes (recommended)*

2.4 Warnings

It is strongly forbidden to spray on humans and animals.

Fix the control levers never in any way whatsoever, except if it is indicated.

The cover must always remain closed while working with the machine.

Always use the auxiliary coupler during transport of the trailer.

Never drive faster than 80 km/h with the trailer.

2.5 Personnel qualification and education

Personnel that use, maintain and inspect the machine must have the right qualifications for this job.

Responsibility and authorisation of the personnel and the supervision on the personnel must be embedded. If the knowledge is not present, the user must provide for the necessarily education.

2.6 Danger that can occur if the security regulations aren't observed

If the security regulations are not observed, danger can occur for personnel and for the environment.

No amends are given if the regulations are not observed.

If the regulations are not observed, this can results in:

- *Failure of important functions of the machine.*
- *Failure of prescribes methods for maintenance.*
- *Exposure of persons to dangers of electrical or mechanical failures*
- *Danger to the environment due to leakage of hazardous substances.*

2.7 Working safely

The in this manual named security prescriptions, the national prescriptions to prevent accidents and the internal labour, company and security prescriptions must be followed by the user.

2.8 Security regulations for the user and technical service

- *Protections of moving parts (for example couplings) may not be removed if the machine is working.*
- *Leakage of dangerous mediums must disposed in a manner that there is no danger for the personnel and environment. Statutory regulations must be followed.*
- *Danger caused by electricity must be excluded.*

2.9 Security regulations for maintenance, inspection and mounting activities

- *The user sees to it that qualified technicians do all maintenance, inspection and mounting activities. They must study the manual thoroughly.*
- *Maintenance may only be done when the machine is not functioning.*
- *The in the user's manual mentioned handling to stop the machine must be notified.*
- *The pump must be cleaned if it has pumped fluids that may endanger health.*
- *Directly after maintenance of the machine, all the security and protection facilities must be functionally.*
- *Before starting the machine again, you must follow the instructions correctly.*

2.10 Making changes and fabricate spare parts

Changes to the machine are only permitted if Rioned has given written authorisation. The use of original spare parts and accessories are for the safety necessary. Rioned is not responsible for injuries or damages if other spare parts are used.

2.11 Improper use

The security during working with the machine is only guaranteed if the use of the machine is conform the user's manual. The limits that are written in chapter "Technical Specifications" and "Appendix" may never be overstepped.

If the machine does not work or give troubles, it is forbidden to work further with the machine. Telephone your dealer or the technical department of your dealer.

This manual contains all the necessary information concerning control and maintenance. If the device is positioned correctly, properly controlled, and regularly maintained, a warranty will be given according to the general conditions of delivery. However, should it arise that the control and maintenance procedures are not diligently followed, the warranty will become invalid.

3 TECHNICAL SPECIFICATION

3.1 General

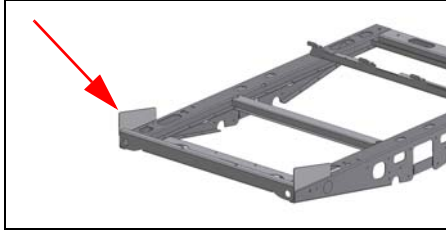
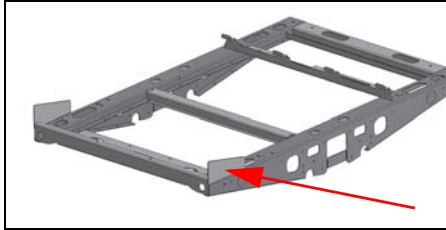
Description (<i>symbol</i>)	Unit
Dimension	: see chapter 11.4 Dimension FlexJet page: 65
Weight (dry and without options) (<i>m</i>)	: ~340 kg / ~ 540 kg (FJ+)
Total weight (without options) (<i>m</i>)	: ~ 750 kg / ~1200 kg (FJ+)
Quantity water tank	: Max 400 l / Max. 550 l (FJ+)
Supply medium	: Water
Maximum temperature medium	: 60 °C
Standard colours	: Yellow/gray or white/gray
Type tyre	: 155R13C 89/91N
Recommended tyre tension	: 4,5 bar
Total length high-pressure hose	: 40-80 m
Diameter high-pressure hose	: 1/2"
Total length supply hose	: 35 m
Diameter supply hose	: 3/4"-5/8"
Place type plate	:
	
Place chassis number	:
	
Quantity oil tank	: 5,5 l
Supply medium oil tank	: Hydraulic oil HESTIA 46
Sound level and measure position	: see chapter 12 Appendix page: 65
Year of construction (<i>month/year</i>)	: 01/18

For more data FlexJet+ [see chapter 11.8 COC page: 69](#)

3.2 Engine

Description (<i>symbol</i>)	Unit
Type	: <i>Vanguard Briggs & Stratton Model 350400</i>
Number of cylinders	: 2
Bore x stroke (<i>d x l</i>)	: 72 x 70 mm
Displacement (<i>V</i>)	: 570 cm ³ (<i>0,57 . 10⁶m³</i>)
Power (<i>P</i>)	: 13,4 kW (<i>18 PK</i>) at 3600 ¹ / _{min}
Fuel	: Normal of unleaded petrol (Euro 95)
Quantity fuel tank (<i>V</i>)	: 13 l (<i>13 . 10⁶m³</i>)
Cooling	: Air cooled
Weight (<i>m</i>)	: 33,3 kg
Battery (<i>U, I</i>)	: 12 V, 45 A
Oil	: 10W30 API/SF-CC or better
Quantity oil	: 1,7 l (<i>1,7 . 10⁶m³</i>)
Dimensions (<i>l x b x h</i>)	: 331 x 406 x 439 mm

Type	: <i>Honda GX630</i>
Engine type	: Air cooled 4-stroke OHV
Bore x Stroke	: 78 x 72 mm
Displacement	: 688 CC
Compression ratio	: 9.3:1
Power	: 20.2 PK (15.1kW)/ 3,600 rpm
Starting system	: Electric
Oil capacity	: 2,2 liters
Battery	: 12 V, 45 A
Oil	: 10W30 API/SF-CC
Dimensions (<i>l x b x h</i>)	: 405 x 410 x 438 mm
Dry weight	: 44,4 kg

Type	: <i>Honda GX690</i>
Engine type	: Air cooled 4-stroke OHV
Bore x Stroke	: 78 x 72 mm
Displacement	: 688 CC
Compression ratio	: 9.3:1
Power	: 22.4 PK (16.5kW)/ 3,600 rpm
Starting system	: Electric
Oil capacity	: 2,2 liters
Battery	: 12 V, 45 A
Oil	: 10W30 API/SF-CC
Dimensions (<i>l x b x h</i>)	: 429 x 450 x 438 mm
Dry weight	: 45,3 kg

For more information concerning the engine you can find it in the book delivered with this machine.

3.3 Pump

Description (<i>symbol</i>)	Unit
Type	: Speck P30
Number of plungers	: 3
Number of valves	: 6
Number of revolutions (<i>n</i>)	: 1420 min ⁻¹
Maximum pressure (<i>p</i>)	: See type plate on frame
Maximum output (V/t)	: See type plate on frame
Oil	: GX 80W90
Quantity	: 0,7 l (0,7 · 10 ⁻⁶ m ³)
Weight (<i>m</i>)	: 19 kg
Dimensions (<i>l x b x h</i>)	: 342 x 282 x 140 mm
Maximum water temperature (<i>T</i>)	: 70 °C (343,15 K)

Type	: Speck P41
Number of plungers	: 3
Number of valves	: 6
Number of revolutions (<i>n</i>)	: 1200 min ⁻¹
Maximum pressure (<i>p</i>)	: See type plate on frame
Maximum output (V/t)	: See type plate on frame
Oil	: GX 80W90
Quantity (V)	: 1 l (1,0 · 10 ⁻⁶ m ³)
Weight (m)	: 30 kg
Maximum water temperature (t,T)	: 80 °C (353,15 K)

Type	: Speck NP25
Number of plungers	: 3
Number of valves	: 6
Number of revolutions (<i>n</i>)	: 1450 min ⁻¹
Maximum pressure (<i>p</i>)	: See type plate on frame
Maximum output (V/t)	: See type plate on frame
Oil	: GX 80W90
Quantity (V)	: 0,9 l (0,9 · 10 ⁻⁶ m ³)
Weight (m)	: 17 kg
Maximum water temperature (t,T)	: 70 °C (353,15 K)

For more information concerning the pump, you can find it in the pump appendix delivered with this machine.

4 CONSTRUCTION

This machine contains the following main parts:

- | | | | |
|-----|------------------------------|-----|---------------------------|
| 1. | Tool box | 13. | Supply valve water filter |
| 2. | Water tank | 14. | Drain valve |
| 3. | Opening water tank | 15. | Engine |
| 4. | Reel with high-pressure hose | 16. | Pump |
| 5. | Reel with supply hose | 17. | Nose wheel support |
| 6. | Valve supply reel | 18. | Swing nose wheel support |
| 7. | High-pressure (HP)-valve | 19. | Tow bar |
| 8. | Machine cover | 20. | Coupling |
| 9. | Control box | 21. | Emergency stop |
| 10. | Pressure regulator | 22. | Fuel tank |
| 11. | Pressure gauge | 23. | Level indicator fuel tank |
| 12. | Water filter | 24. | Battery |

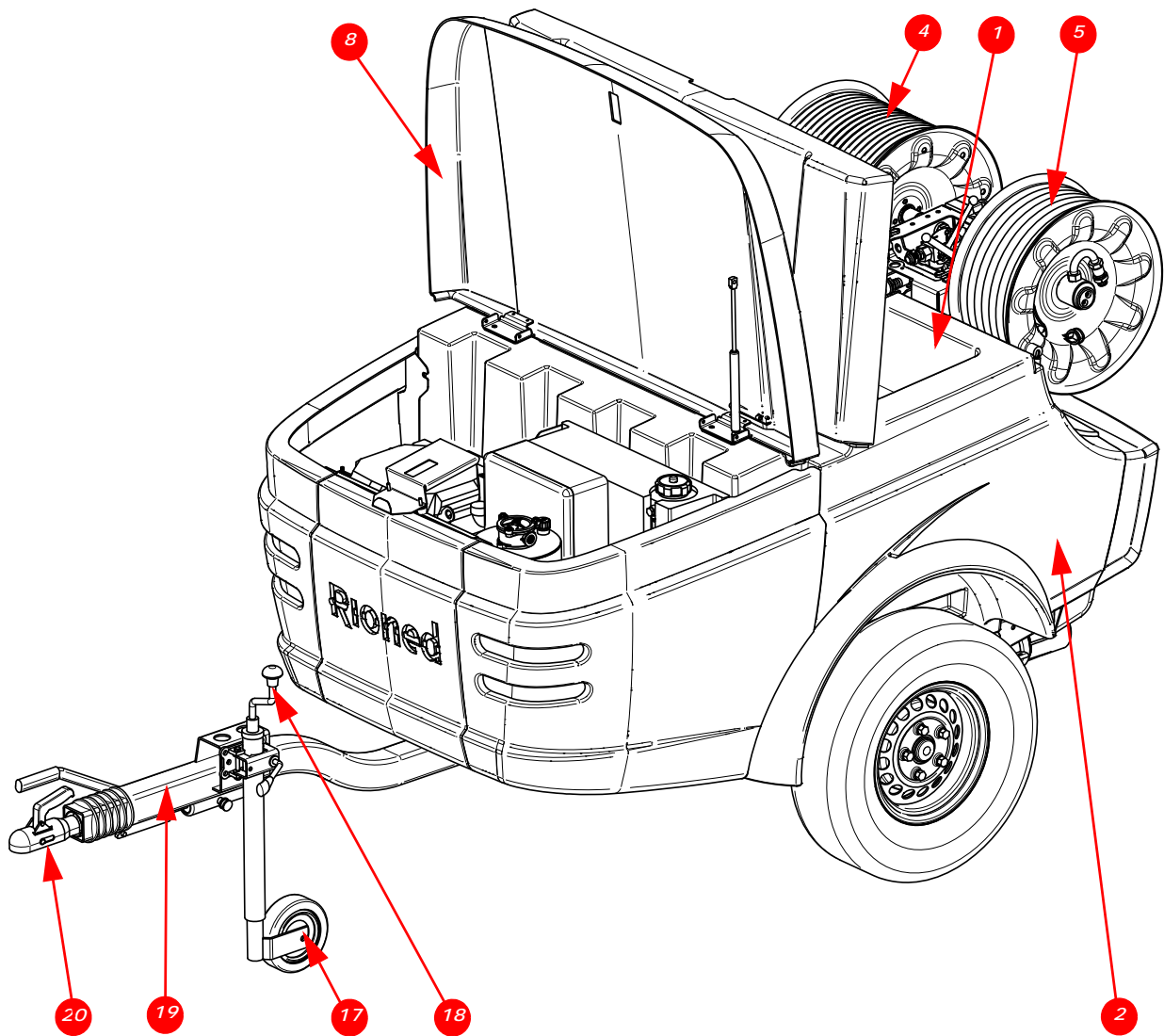

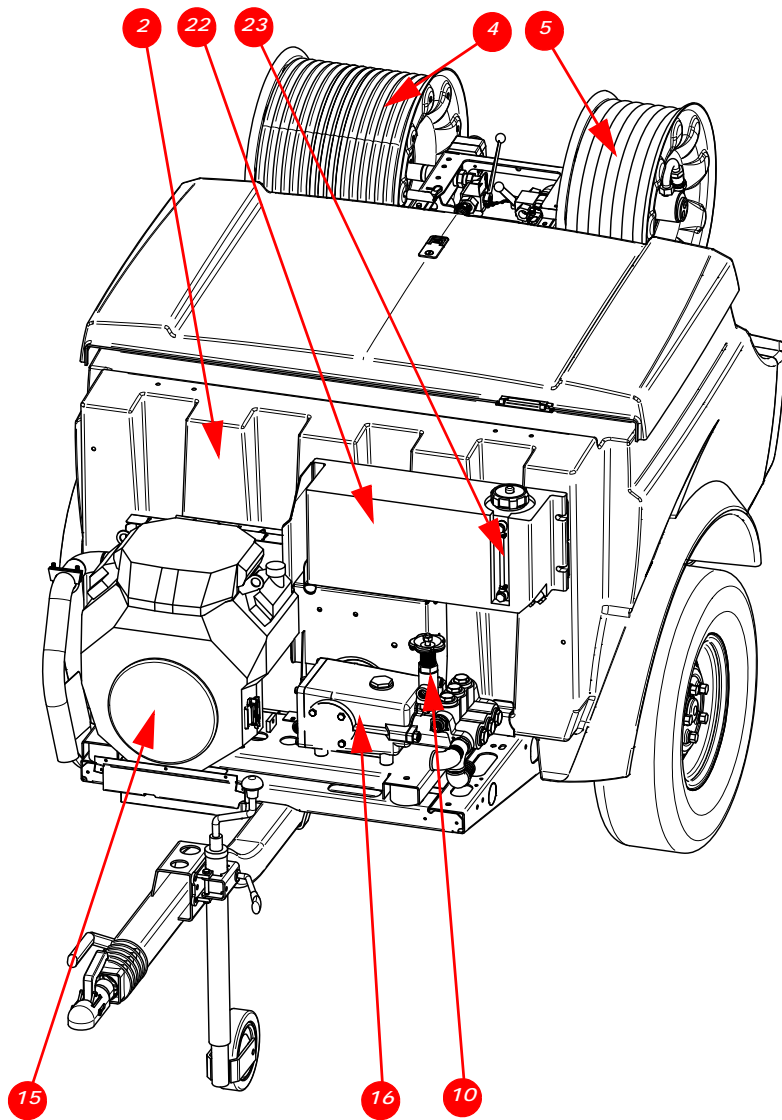
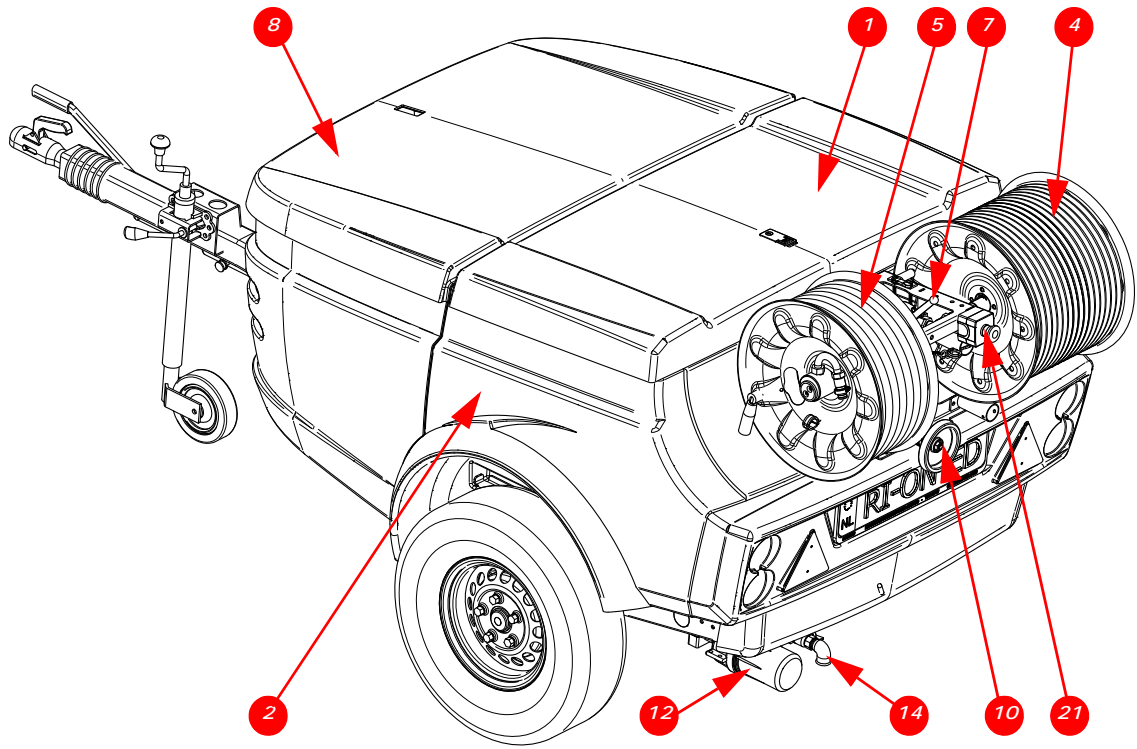

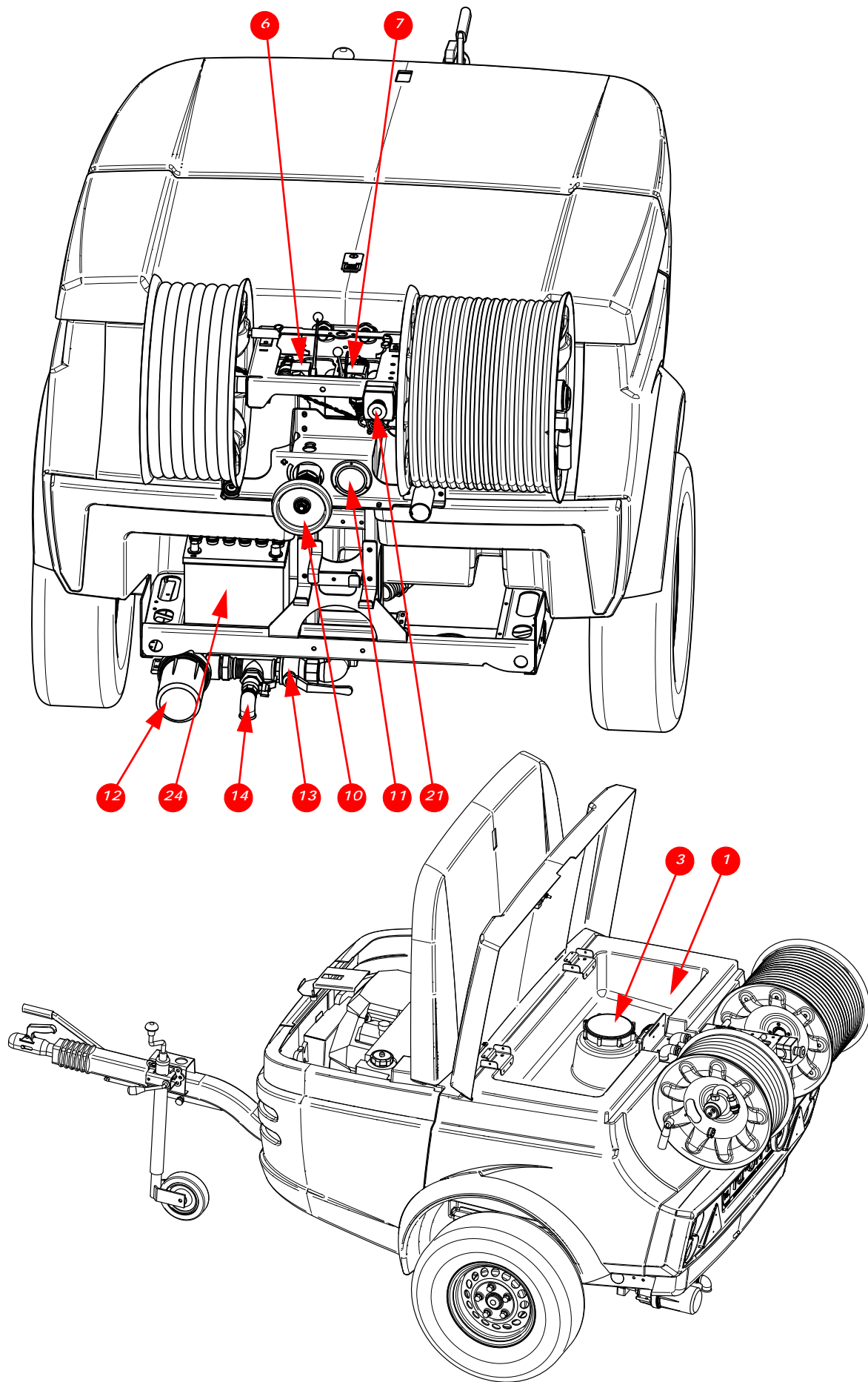

5 CONTROL



If you control, maintain or inspect the machine, you must have the right qualifications for this job. If you do not have the necessarily knowledge, you may not use the machine. Further, you must convince yourself that you understand this manual thoroughly.

5.1 Hitching up the trailer

If you want to drive with the trailer, the trailer must be connected to your vehicle.

Proceed as follows:

1. Pull the safety break handle up (*Illustration 5.1.1 E*).
2. Place the tow bar of the trailer onto the ball of the hitch on your vehicle.
3. Check whether the trailer is more or less horizontal. If it is not, the hitch will not be at the required height (heart cone between 38 and 42 cm from the ground) and your car will not be able to tow the trailer.
4. If the hitch on the car is at the required height, push the safety lock (*Illustration 5.1.1 B*) downwards.
5. Check whether the pin (*Illustration 5.1.1 A*) for the safety lock is in between the marks.
6. Attach the safety cable to the eye which has been specially installed for this purpose. This cable should not be pulled tightly or become caught in any part.
7. Put the plug for the trailer into the socket on the car. Check whether the rear lights function properly.
8. Raise the support completely (*Illustration 5.1.1 C*) and secure it by turning the bolt (*Illustration 5.1.1 D*); now the tow bar of the trailer rests on the ball and hitch on the car.

Illustration 5.1.1

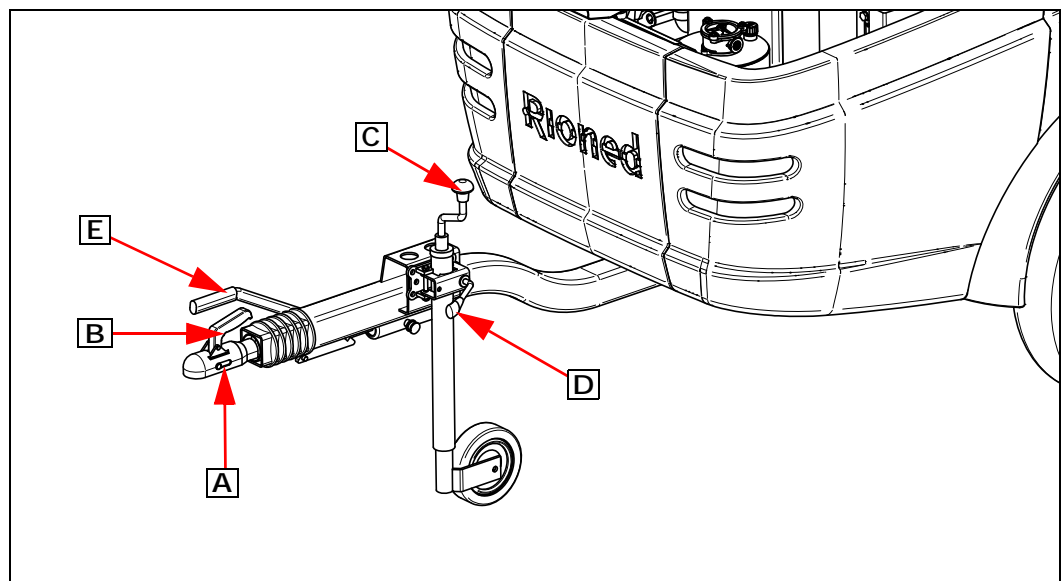

5.2 Check before departure

Before you drive away with the vehicle, check the following:

1. Are the supports at its full height and locked? (Option)
2. Is the high-pressure hose (4) been inserted into the hose holder and secured with the securing pin.
3. Is the high-pressure hose reel (4) locked by means of the reel lock or is the hydraulic reel control handle been put into position "O" (fixed).
4. Is the supply hose (5) been connected to the GK coupling.
5. Is the supply hose reel locked by means of the reel lock.
6. Is the tyre tension of the trailer enough.
7. Do the brakes function adequately (only FlexJet+).
8. Empty the water tank.
9. In case of frost, flush pipes with antifreeze!



Warning!

Never drive faster than the maximum speed for trailers!

The trailer is now ready for transport.

5.3 Unhitching and setting up

1. Place the trailer in position.
2. Block, by use on a slope, the wheels with a wedge.
3. Lower the support completely and secure in place (option).
4. Disconnect the plug for the rear lights.
5. Release the safety cable from the eye.
6. Unhitch the trailer from the car. Pull up the handle on the tow bar and then slant towards the front.
7. Lower the two support legs and lock them by turning the clamping bolts. See to it that the trailer is more or less level.
8. Pull the hand brake of the trailer and lower the nose wheel somewhat in order to increase the stability of the trailer.
9. Mark the working area according the local regulations.

5.4

Control box

A	Emergency stop
B	Oil pressure
C	HP open / Start spraying
D	Throttle open
E	Hour counter
F	Charging
G	Run dry protection
H	HP close / Stop spraying
I	Throttle close
J	Ignition key

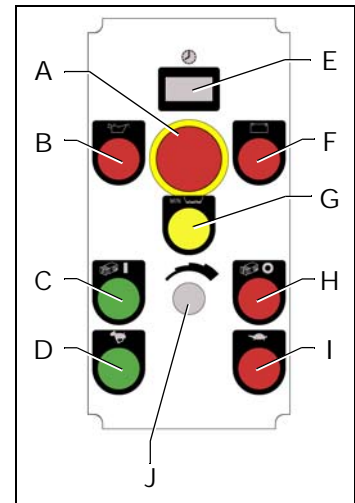

5.5

Radio remote control

1. Put the 7-pins plug into the socket.

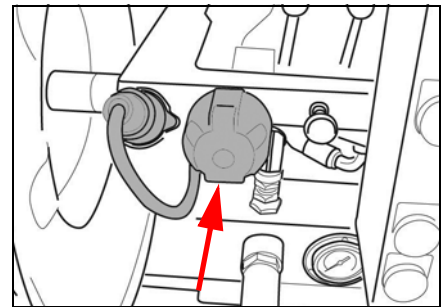

Attention!
When the 7-pin plug is into the connector, the functions of the control box will fall off. Nevertheless remains the emergency stop switch working.

5.6

Before starting

1. Check the oil level in the engine (15), oil reservoir (option) and high-pressure pump (16) using the dipsticks. Add oil, if necessary.
2. Add fuel in the fuel tank (22).
3. Check whether the water filter (12) is clean. Clean the filter, if necessary; see "Maintenance".
4. Check whether the high-pressure valve (7) on the reel is closed.
5. Check whether the supply valve (13) to the water filter (12) has been opened.
6. Fill the water tank.
This can be done in several ways:
 - a Via the supply hose (5).
Unlock the supply reel and couple the end of the supply hose onto a water tap. Open the water tap and the supply valve.
 - b Manually:
The water tank (3) can be filled with water via the manhole on the water tank.

The maximum water temperature is 60 °C (140 °F).

7. Turn the control wheel of the pressure regulator (10) counter clockwise.
8. Screw the appropriate attachment onto the high-pressure hose.
 - a. Unclogging of a drain: jet nozzle

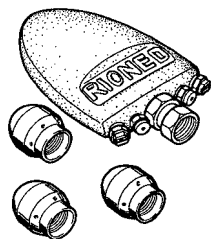

- b. Cleaning a wall, a terrace or floor: spray lance gun

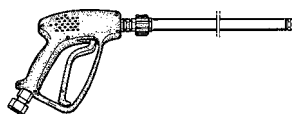

5.7 Starting the machine



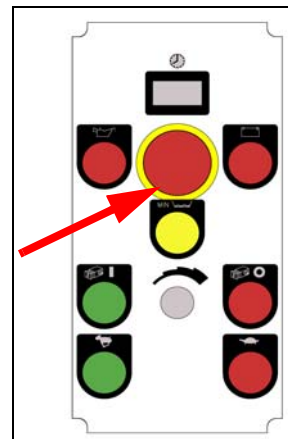
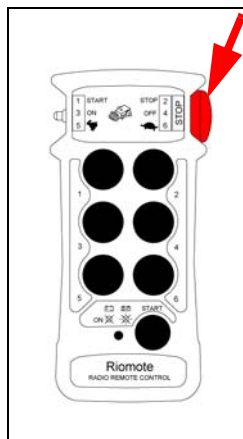
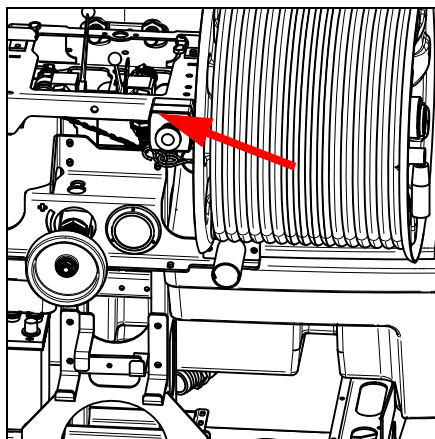







 **Emergency stop:** The machine is equipped with an emergency stop. By operating this stop the machine will stop immediately.



- Do not use the button for normal stopping.
- Only use is when dangerous situations occur.
- After use, turn the emergency stop in order to be able to start up again.
- Make sure the emergency stop can always be reached.

Oil Alert lamp petrol engine:

Execution:	B&S	Honda 20hp	Honda 24hp
Switch:	Pressure	Level	Level
Standard, without control box	Oil alert engine lamp lights when "ignition on".	Lamp is off at "ignition on"	not applicable
	Lamp goes out with running engine.	Lamp is off with running engine.	not applicable
	No pressure: lamp burns; engine falls off.	Lamp burns with low oil level; engine falls off.	not applicable
Standard, with control box.	Lamp burns with "Ignition on".	Lamp is off at "ignition on"	Lamp is off at "ignition on"
	Lamp goes out with running engine.	Lamp is off with running engine.	Lamp is off with running engine.
	No pressure: lamp burns; engine falls off. Scheme 005.000.280	No pressure: lamp burns; engine does not falls off. Scheme 005.000.274	Lamp burns at low oil level; engine does not falls off. Scheme 005.000.274
5-channel remote (small print).	Lamp is off at "ignition on"	Lamp is off at "ignition on"	Lamp is off at "ignition on"
	Lamp goes out with running engine.	Lamp is off with running engine.	Lamp is off with running engine.
	No pressure: lamp burns; engine falls off. Scheme 005.000.394	Lamp burns with low oil level; HP close, throttle close, engine does not falls off (equal with run dry). Scheme 005.000.395	Lamp burns with low oil level; HP close, throttle close, engine does not falls off (equal with run dry). Scheme 005.000.395

Execution:		B&S	Honda 20hp	Honda 24hp
Switch:		Pressure	Level	Level
Standard, without control box.	Ignition on:	 (Oil alert on engine)		not applicable
	Engine runs:			not applicable
	Low oil level:	 Engine stop		not applicable
Standard, with control box.	Ignition on:			
	Engine runs:			
	Low oil level:	Engine stop	 No engine stop	 No engine stop

Execution:		B&S	Honda 20hp	Honda 24hp
5-channel remote (small print).	Ignition on:			
	Engine runs:			
	Low oil level:	 Engine stop	 HP close; throttle close; No engine stop	 HP close; throttle close; No engine stop

Start the engine.



Important!

If the machine has run out of water, ensure that the hose is unwound before pressurising!

Starting on engine (B&S)

1. Pull the choke handle.

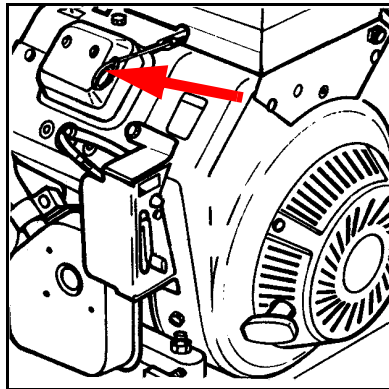

Tip!

The choke is not needed if the engine or outside temperature is hot.

2. Start de engine.
 - With the pull cord.
 - a Turn the key a quarter turn clockwise.
 - b Pull the starter cord slowly until resistance is felt.
 - c Pull the cord rapidly to avoid kickback.



Caution!

Do not allow the starter grip is gripping to the engine. Move it quietly back to prevent damage to the starter.

- With electric starter

- a Turn the ignition key to the right and keeps him there until the engine starts.



Caution!

Do not use the electric starter for more than 15 seconds. You will damage the starter.

If the engine refuses to start, release the ignition start button and wait 1 minute to start again.

Let the ignition key go back to position "RUN" when the engine starts.

3. Let the engine warm up. After 3 minutes warming up the machine is ready for use.
4. Close the choke if needed.

For a more detailed description see the enclosed engine book or Internet site: (http://www5.briggsandstratton.com/eu/en/pdf/owners_manual/100/278389WST_--GB.pdf)

Starting on engine (Honda)

- | | |
|---|-------------------------|
| A | Throttle handle |
| B | Choke |
| C | Ignition |
| D | Hour counter |
| E | Oil alert warning light |

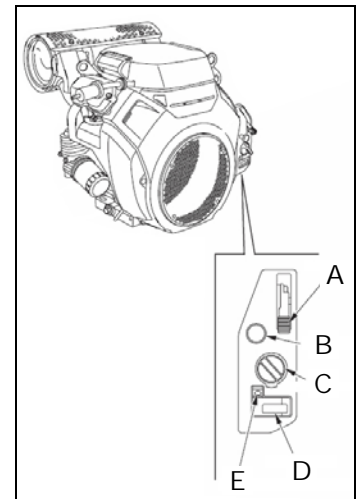

1. If the fuel tank is equipped with a valve, be sure the fuel valve is in the OPEN or ON position before attempting to start the engine.
2. To start a cold engine, pull the choke knob out to the CLOSED position.
3. Move the throttle lever away from the MIN. position, about 1/3 of the way toward the MAX. position.
4. Turn the engine switch to the ON position.
5. Operate the starter.
6. Turn the engine switch to the START position, and hold it there until the engine starts.
If the engine fails to start within 5 seconds, release the engine switch, and wait at least 10 seconds before operating the starter again.
7. When the engine starts, release the engine switch, allowing it to return to the ON position.
8. Warm up the engine for 2 or 3 minutes. If the choke knob was pulled to the CLOSED position to start the engine, gradually push it to the OPEN position as the engine warms up.

For a more detailed description see enclosed engine book or Internet site. (<http://engines.honda.com/pdf/manuals/00X37Z6L6010.pdf>)

Starting on control box:

1. Insert the key into the ignition (A).
2. Turn the key one turn to the right.
3. Check the indicator lights "Oil pressure" (B) and "Battery" (C) light.
4. Turn the key (A) further and release the key once the engine starts.

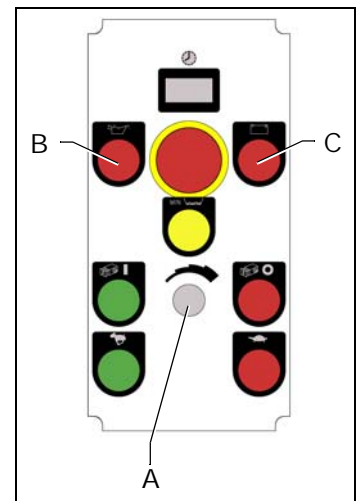

Starting with Riomote transmitter (optional):

5. Press button 1 in (Engine starts).

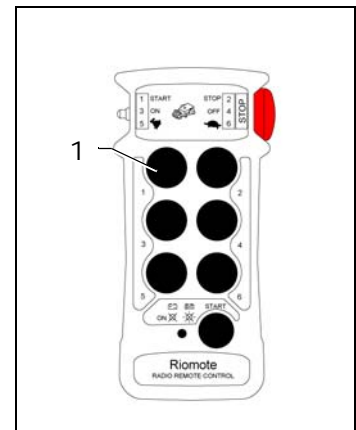

Use, if necessary, the choke!

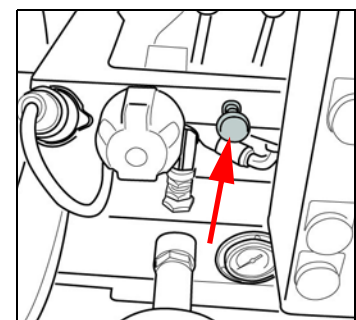

5.8

Unclogging a drain

-  **Attention!**
Ensure that the spraying nozzle does not leave the drain!
Water under high-pressure may cause severe injuries!



1. Screw a suitable nozzle onto the high-pressure hose.
2. Unwind the hose (see chapter 7.1 "Hydraulic reel control" page.: 41).
3. Put the nozzle into the drain that is to be cleaned.
4. Screw the high-pressure regulator (**10**) fully open (right).

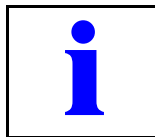

• Use an input guide support and / or a "Hose inlet guidance rolls" to protect the outer jacket of the HD-tube against damage.

Control

1. Open the high-pressure valve.
2. Screw the pressure regulator fully to the right.

Control on machine with control box:

3. Press button C (HP pump On).
4. Press button D (Throttle open).

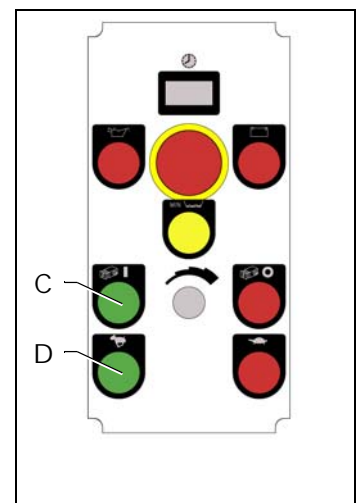

Control by Riomote remote control (option):

5. Press button 3 or (HP pump on).
6. Press button 5 or (Throttle Open).

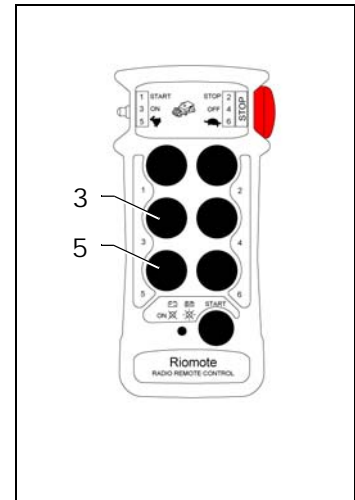

Via the Flexmote remote (option):

7. Press short button 2 (HD on).
8. Press long button 2 (Gas open).

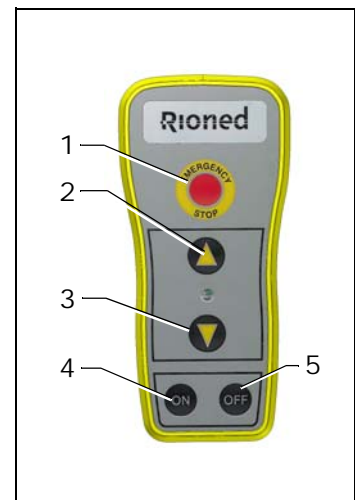

The hose will now unwind and work its way into the drain.

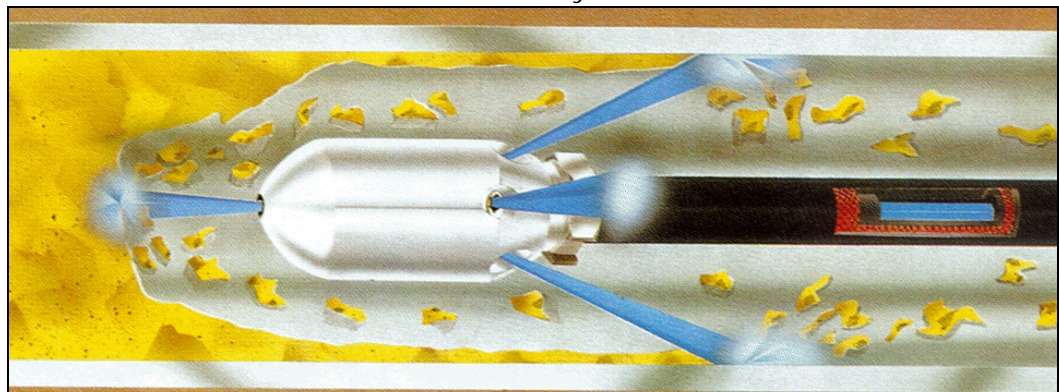

9. Check that the water drains away. When the blockage has been cleared, continue to flush for a while. At the same time wind the hose up slowly.



Important!

Rewind hose onto reel under pressure to avoid crushing. If machine has run out of water, ensure hose is unwound before pressurising.

5.9

Stop spraying:

Control on machine:

1. Press button I (Throttle close).
2. Press button H (HP pump off).

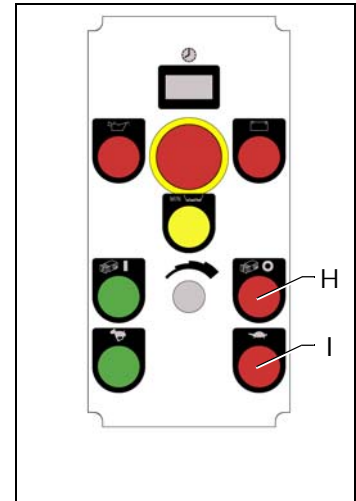

Control by Riomote remote control:

3. Press button 6 (Throttle close).
4. Press button 4 (HP pump off).

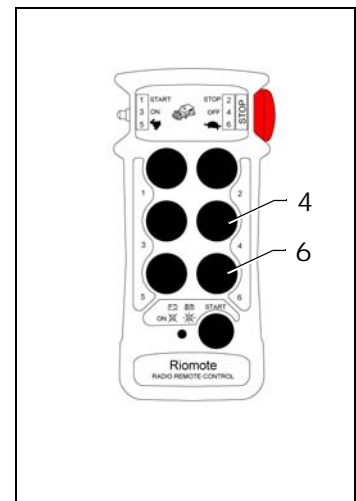

Via the Flexmote remote (option):

5. Press button 3 (Throttle close and HD off).
6. Close the High-pressure valve.

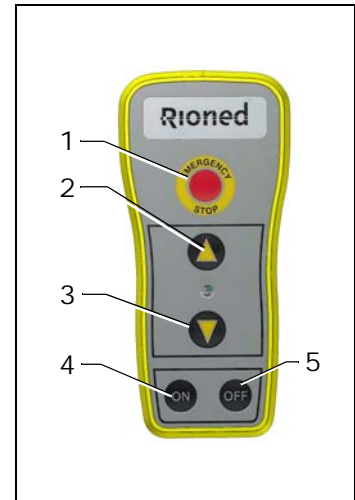

Treat the high-pressure hose carefully:

- Always clean it after use.
- Ensure that no sharp objects are near the hose.
- Ensure that no traffic crosses the hose.
- If the hose has to be repaired, use only the special repair couplings.

5.10 Cleaning a wall, terrace or floor.

 **Caution!** Before using a spray gun, you must always set the pressure below the maximum (\pm the half of the maximum pressure).

- You must do this before you start the machine.
- If the machine is running, the pressure can be increased by turning the control wheel to his working pressure.
- Never exceed the maximum pressure that is marked on the manometer when using the spray gun.

Before cleaning:

1. Screw the spray gun including in the delivery onto the high-pressure hose. Fasten it by using the two spanners provided.
2. COMPLETELY unroll the high-pressure hose.
3. Attach the spray lance gun. Secure the quick coupling tightly.
4. Open the HP valve.

Control:

Control on machine with control box:

5. Press button C (HP pump On).
6. Press button D (Throttle open).

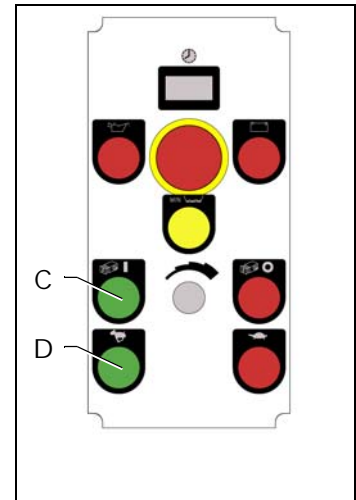

Control by Riomote remote control (option):

7. Press button 3 or (HP pump on).
8. Press button 5 or (Throttle Open).

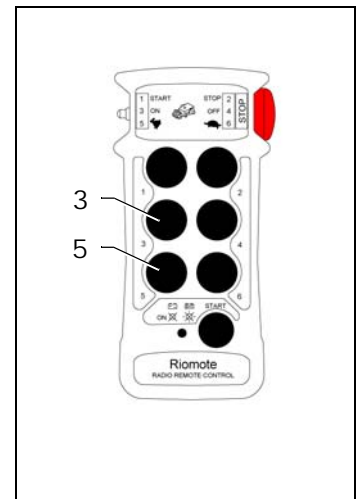

Via the Flexmote remote (option):

9. Press short button 2 (HD on).
10. Press long button 2 (Gas open).

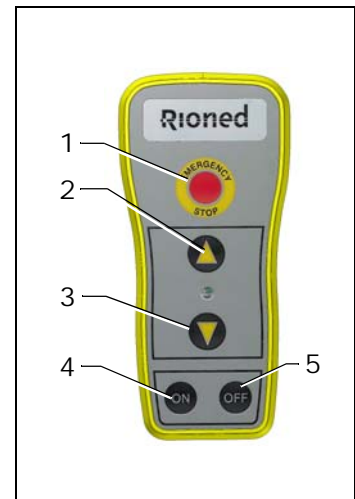

5.11 Spray with spray lance

1. Screw the high-pressure regulator wheel upward on the high-pressure regulator until the required working pressure is reached.
 - *The adjusted pressure can be read from the pressure gauge on the machine when the spray gun is open.*
2. Aim the lance at the surface.
3. Pull the trigger of the spray gun. Release the trigger and the spraying stops.

Stop working:

Via de control box:

1. Press button I in (Throttle close).
2. Press button H in (HP off/stop spraying).

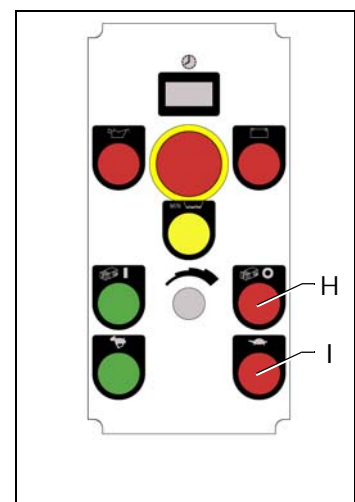

Via the Riomote transmitter (option):

3. Press button 6 (Throttle close).
4. Press button 4 (HP off/stop spraying).

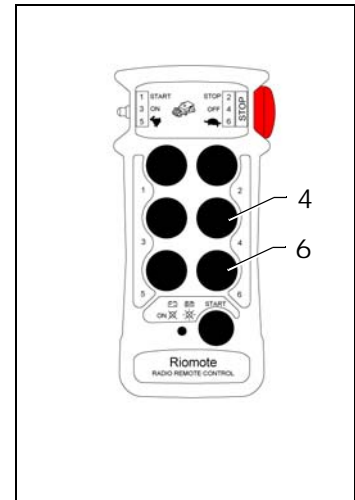

Via the Flexmote transmitter (option):

5. Press button 2 (Throttle close and HP off/stop spraying).

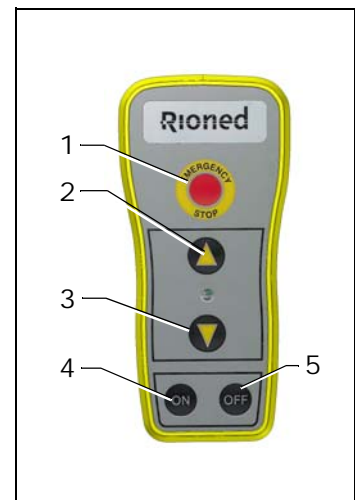

6. Close the HP valve.

Mark!
Pull the trigger of the spray gun once more to depressurise the HP hose.

Instead of the spray lance gun, you can also mount a NW5 hose with small nozzle onto the spray gun. This set can be used for unclogging small pipes. The water supply can be used for unclogging via the gun. In this way you can prevent the system from flooding the surroundings.

Always treat the high-pressure hose well!

Illustration:
Spray gun with
NW 5 hose

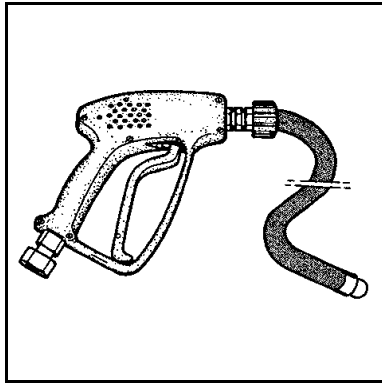

5.12 Stop the engine

With the control box:

1. Turn the ignition key fully to the left.

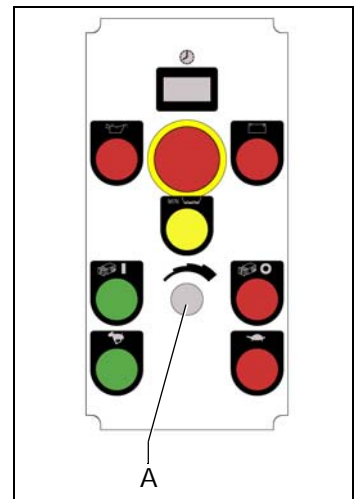

With the Riomote transmitter (option):

1. Press button 2 (Engine stop).

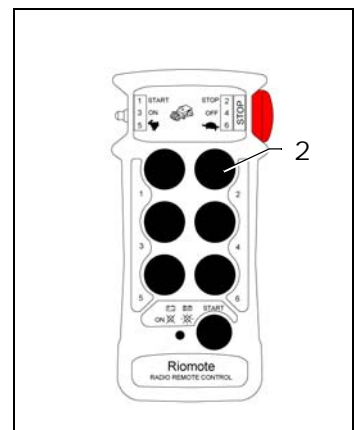

5.13 Ending duties

At the end of the duties you proceed as follows:

1. Stop the engine.
2. Tidy up the HP reel.
 - a Close the HP valve.
 - b Wind up the HP hose.
 - c Lock the HP hose in the hose holder.
 - d Lock the HP reel (position "O").
 - e Lock the hose guide.
3. Tidy up the supply hose.
 - a Close all water taps.
 - b Close the supply tap.
 - c Uncouple the supply hose.
 - d Wind the supply hose.
 - e Couple the end of the supply hose to the frame.
 - f Lock the supply reel.
4. Tidy up all accessories.
5. Tidy up the remote control.
6. Drain the water that is still left in the water tank by means of the draw-off tap.
7. Couple the trailer to your car.

The trailer can now be moved.

5.14 Using the device during periods of frost

Your high-pressure device may freeze up during a period of frost. A number of safety precautions must be taken.

Additional preparations before departure:

1. Drain the water tank and the water filter.
2. Close the drain valve and mount the filter again.
3. Put approximate 30 litre of antifreeze into the anti freeze tank.
4. Open the anti freeze valve.
5. Open the high-pressure valve.
6. Start the machine and let it idle.
Note: it is not necessary to attach either a nozzle or a gun to the high-pressure control.

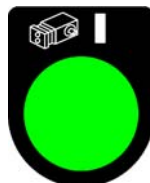

7. Push button (Start spraying) on the control box.
8. Let the high-pressure pump remove all the water, which is still in the high-pressure hose.
9. Close the high-pressure valve when anti freeze comes out of the hose (wait for the blue colour of the antifreeze).
10. Leave the engine running for some time: to allow all pipes to fill up with antifreeze.



11. Push button (Stop spraying) on the control box and close the HP valve.
12. Connect the high-pressure hose to the water fill hose using a special GK hose coupling.

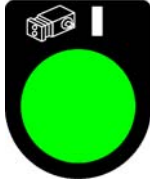

13. Push button (Start spraying) on the control box and open the HP valve.
14. Let the high-pressure pump fill the supply hose with antifreeze.



15. Push button (Stop spraying) on the control box and close the HP-valve.
16. Switch off the machine.

Now the machine is ready for departure!

5.15

Additional preparations when preparing for use:

1. Connect the high-pressure hose at the antifreeze tank.
2. Turn on the machine and let the high-pressure pump drain all anti-freeze into the antifreeze tank.
The antifreeze can be reused. Ensure that no water is mixed with the antifreeze. If water gets into the antifreeze, it is not suitable for re-use. Dispose the used antifreeze properly, hand it into a local depot for disposal of industrial waste.
3. Stop the machine and prepare it for use.

6 SYMBOLS

6.1 Control box



Engine start.



Engine stop.

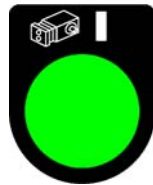

Start spraying (HP pump ON)

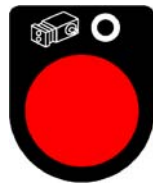

Stop spraying (HP pump OFF)



Throttle open (more water and more pressure)



Throttle close (less water and less pressure)



Signal lamp "Charging" (*Burns if there is no charge to the battery*).



engine).

Signal lamp "Oil pressure" (*Burns if there is not enough oil in the*

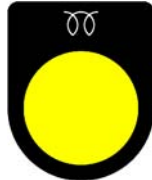

warmed up).

Signal lamp "Glowing" (*Burns when the glow spiral in the engine is*



Run dry protection

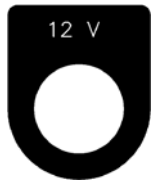

12 volt accessories



Radio remote control

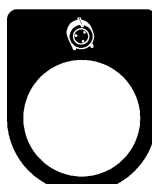

Cable remote control on.



Hand control on.



"Hand" or "Radio remote" control

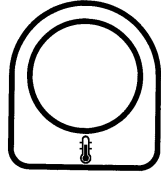

Signal lamp "Temperature engine to high"

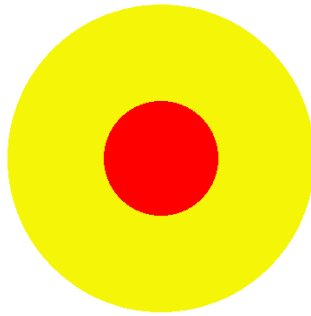

Back plate "Emergency stop"

6.2 Pressure gauge

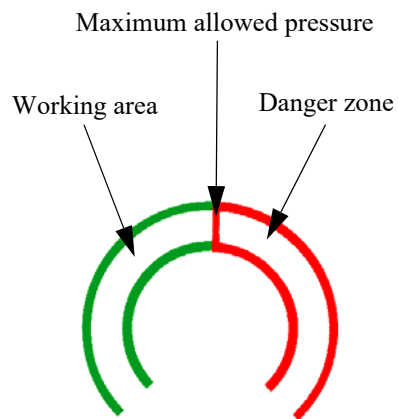

6.3 Pressure regulator

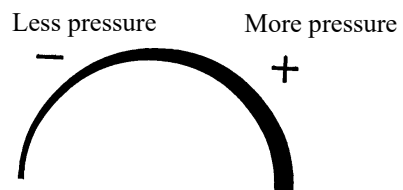

1. Gehör- Kopf- und Augen Schutz tragen verpflichtet.
2. Sicherheitsschuhe mit extra Schutz verpflichtet.
3. Betriebsanleitung studieren verpflichtet.
4. Sicherheitshandschuhe mit Pulsschutz verpflichtet.
5. Schutzkleidung verpflichtet.
6. Kein Trinkwasser.
7. Gefahr für rutschen.
8. Pas auf für Handverletzung.
9. Drehende Maschine.
10. Achtung für automatische anlassende Maschine.

1. You must wear ear- head- and eye protection.
2. You must wear security shoes with extra protection.
3. Read the user's manual.
4. You must wear safety gloves with wrist protection.
5. You must wear protection cloth.
6. No drinking water.
7. Slip danger.
8. Look out for hand damage.
9. Turning machine.
10. Warning for automatically starting machine.

1. Gehoor- hoofd- en oogbescherming dragen verplicht.
2. Veiligheidsschoenen met extra bescherming verplicht.
3. Handleiding lezen verplicht.
4. Veiligheidshandschoenen met polsbescherming verplicht.
5. Beschermende werkkleding verplicht.
6. Geen drinkwater.
7. Gevaar voor uitglijden.
8. Pas op voor handletsel.
9. Draaiende machine.
10. Waarschuwing voor automatisch startende machine.

1. Protection obligatoire des gueux, de l'ouïe et de la tête.
2. Protection obligatoire des pieds.
3. Obligation de lire le manuel d'utilisation.
4. Protection obligatoire des mains.
5. Protection obligatoire du corps.
6. Eau non potable.
7. Attention Risque de sol glissant.
8. Attention Risque d'écrasement.
9. Attention Risque de dangers divers.
10. Attention Risque de démarrage automatique a tous moments.



7 OPTIONS

7.1 Hydraulic reel control

By means of pushing the control lever upwards or downwards the high-pressure hose can be unrolled or rolled up. Due to the proportional functioning of this valve you can also control the speed of the reel. By putting the lever into the position you can unroll the hose manually.



Attention!

Never block the lever and always control it with one hand while guiding the high-pressure hose by means of the hose guide with the other hand to the required place.

- A Wind the hose
- B Reel locked
- C Unwind the hose
- D Reel "out of gear"
- E Reel rotates faster
- F Reel rotates slower

7.2 Hose guide

Purpose:

To guide the HP hose into the sewer.

To wind the HP hose on the reel drum.

Use:

- Only use the hose guide in his lower position (horizontal).
- Put the end of the hose through the opening of the hose guide.
- By moving the hose guide to the right and left, you can wind the HP hose fluently on the reel drum.
- After use, put the hose guide vertical and lock the support. Clamp the hose guide.

Advantage

- No dirty hands
- Hose lives longer
- More freedom of movement
- Security
- Hose stays cleaner

7.3 Hour counter

This machine is equipped with an hour counter.
The weight of the machine is shown by means of an hour counter. The hour counter indicates the number of working hours that the machine has worked.

7.4 Run dry protection

Purpose:

The run-dry protection has the purpose to protect the high-pressure pump

Functioning:

If the water level in the tank is too low, the run-dry protection activates.
(The valve closes and the throttle is turned back. Engine idles)

Cancelling:

Fill the water tank. (Supply hose, Fill opening, Supply pipe...)

Bridge:

Press button G continuously during starting the engine.

Use this function for:

- Suction ventury.
The water is used for creating a vacuum in the ventury and thereby suck the surface water.
- Frost protection.
The last remaining water is pumped out of the water tank.

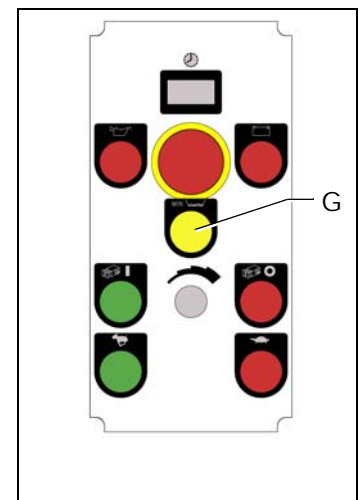

7.5 Water level control

Purpose:

Continuously working with the machine

Functioning:

A floating switch is built in the water tank. This switch controls the solenoid at the supply pipe. Is the water level too high, the solenoid closes. Is the water lev-

el to low, the solenoid opens. You are always sure of water during working with the machine.

Installation:

1. Couple a supply hose on to the coupling of the supply pipe or use the supply hose.
2. Open the water tap.
3. Switch on the level control.

Now the water tank gets filled with water.

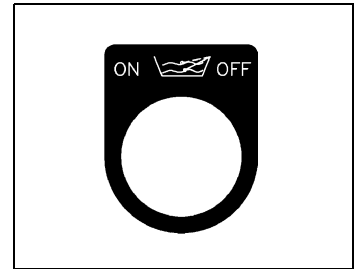

Stop filling the water tank:

1. Close the water tap.
2. Switch off the level control.
3. Depressurize the supply pipe. Press the button.
4. Uncouple the supply hose.

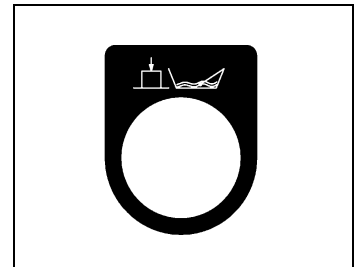

7.6 Suction Ventury

Purpose:

The suction ventury takes care that you can pump dirt and/or liquid out of reservoirs.

Operation:

The water in the water tank is pumped through the ventury. In the ventury forms a vacuum. This vacuum causes the surface water is sucked up. All the water mixes and ends up in the water tank

Preparations:

You must always check if there is enough water in the water tank. If this is not the case the ventury never works.

Use:

1. Connect the coupling of the HP hose onto the coupling of the suction ventury.
2. Place the basket of the suction hose in the surface water.
3. Open the tap.
4. Turn on the high pressure pump.

The water tank is filled now with surface water.

Suction stop:

1. HP pump off.
2. Close the tap.
3. Disconnect the suction hose and store it.

7.7 2e HP-reel instead of supply reel

The operation of a second high-pressure hose reel is equal to that of a high-pressure hose reel. Only the technical specifications may be different. The use of both high pressure hoses at the same time is possible, however, this has consequences for the output.

7.8 Check valve in supply pipe

The check valve prevents, during the filling of the water tank, that water can flow back into the water mains.

7.9 License Plate Holders

Lets you easily change the license plate.

7.10 Working lamp

Control:

By means of switch  you can turn the working lamp ON and OFF.

7.11 Warning beacon

By turning the switch  to position "I" the beacon begins to work. If you turn it to position "O" the operation of the beacon stops.

7.12 Pulsator system

Purpose: With less water use, quicker to the stoppage.

Construction:

The high-pressure pump has three cylinders. By normal use the three cylinders follows each other continuously. This gives a fluent volume stream. To stop one stroke, you get a pulsating water stream.

Control:

1. Unlock the HP reel.
2. Do not let the engine idle.
3. Open or close the handle to start or stop the pulsator.

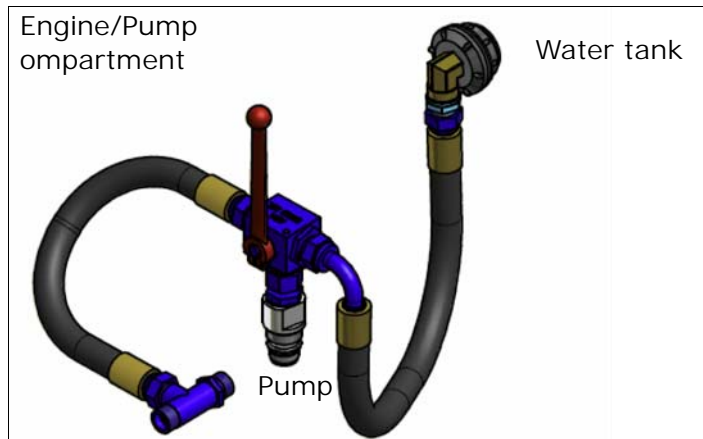

Use:

Use the pulsator system only to get quicker to the stoppage. Stop the pulsator when you are to the stoppage.

Use the machine mentioned earlier in this user's manual.

If you have an electric pulsator the control is as follows:

- Switch to the right is on.
- Switch to the left is off.

7.13 Radio remote control

Purpose: To operate the high-pressure machine from a distance.

To operate the transmitter

Check before working with the transmitter if the emergency stop works well. Proceed as follows:

- Insert the 7-pin plug into the contact.

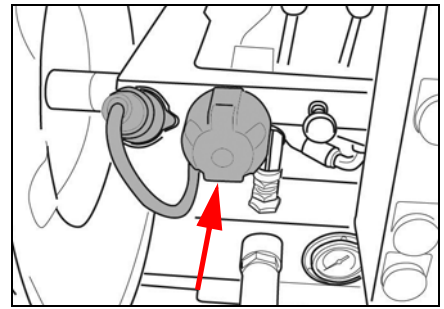

- Switch  on control box at

“Radiographic operating”



- Switch the transmitter on



- Start the engine by means of button “START”



- Push the “STOP” button



The machine has to cut off now

If this is not the case it is not allowed to work with the transmitter. Contact your supplier.

If the indication  on the transmitter starts burning it indicates that the battery must be changed with a new fully loaded battery.

If the battery isn't changed the transmitter switches off in a short time.

Reload empty batteries.

Functions:

1. Start the engine
2. Stop the engine
3. High-pressure pump on (start spraying)
4. High-pressure pump off (stop spraying)
5. Open gas of the engine
6. Close gas of the engine
7. Emergency stop
8. Transmitter on/off
9. Indication light battery

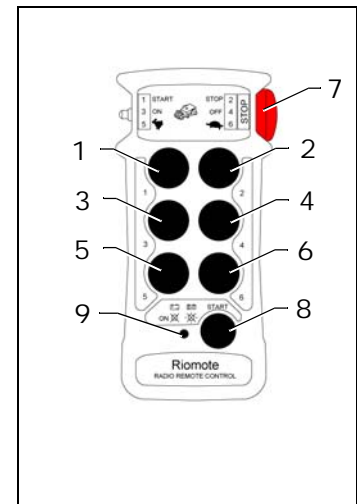

Trouble shooting

- Every system is checked on high quality before leaving the factory. If any disturbances would appear, check the part "trouble shooting"

7.14 Radio remote control (Flexmote)

Purpose: To control the machine remotely.

Key features:

Transmitter activate and hold the "ON" button a half second.

Transmitter deactivation: hold the "OFF" button for half a second.

The emergency stop button is always active, so in panic situations no time is lost!

Standard keys are not simultaneously activated.

Control transmitter.

Transmitter features:

1. Emergency stop.
2. Push button briefly: HP open.
Long press: More throttle.
3. HP close and throttle close.
4. Transmitter on.
5. Transmitter close.

Check before working with the transmitter if the emergency stop works well.

Proceed as follows:

1. Insert the 7-pin plug into the contact.
2. Transmitter on (4).
3. Start the engine
4. Transmitter off (1).

The machine has to cut off now.

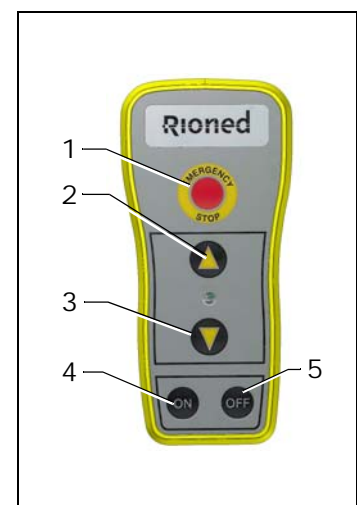



If this is not the case it is not allowed to work with the transmitter. Contact your supplier.

Technical specification:

Receiver:

Voltage	: 8-38 Vdc
Fuse	: 10 A (fast)(5*20mm) glass fuse integrated
Current consumption	: 15 mA
Max. Output rated current	: 4A (met 24 Vdc) per output
Cable length	: 2.5 meters
IP classification	: IP-68 (fully waterproof)
Transmitter	: Range up to 350 meters
Operating Frequency	: 868 MHz
fully waterproof	: Integrated
Power Consumption Standby	: 2 μ A.
Power consumption during transmission	: 5 mA (max.)
Replace Battery Indicator	: When LED flashes slowly when transmitting, battery
Battery type	: 1 piece, 9V 600 mAh
Continuous battery life	: 100 hour
Normal battery life	: 2 years
Impact resistant	: Tot 2 meter
IP classification	: IP-65 (splash proof)

Change battery at transmitter:

Carefully open the casing so that the ribbon cable between the upper and lower house is not damaged. Alternatively, you can disconnect the ribbon cable through the upper part of connector vertically to contract, pushing the flat cable is released. Now replace the battery. Plug ribbon cable back in and press the connector down. Close the case, make sure the ribbon cable is not kinked. Screw the cover back on.

7.15 Water circuit circulate

On the water tank, there are two connectors to connect the ends of the high-pressure hoses to the fixed link. Using this option is for the prevention of freezing of the water circuit.

Use:

1. Start the engine and let it idle.

2. Couple the HP hose onto the water circuit circulation connection on the water tank.
3. Open the HP tap.

The water circulates now through the pipes.

8 MAINTENANCE



Attention!

Always stop the engine first and depressurize the system before serving or repairing the machine.

To depressurize the system, you open the HP valve. If the spray lance gun is attached you must also pull the trigger.

8.1 Daily maintenance

1. Oil level

Check all oil levels once a week. Add oil, if necessary.

If an oil level has dropped, this implies a leak in the system. In which case, check all gaskets, couplings, and (hydraulic) pipes in the system. Immediately repair damage and fill the system with the correct oil.

Mark!

During the settling-in period, the oil consumption of the engine can be more than usually.

2. Cleaning water filter:

- a Close the supply valve in the suction pipe.
- b Unscrew cap from the filter piece.
- c Clean the filter and concerning parts.
- d After cleaning, assemble the parts in opposite order
- e Open supply valve.
- f Check for leakage.

8.2 Weekly maintenance

Cleaning:

Clean the carriage weekly. Use car shampoo and plenty of water.

Especially when there is sprinkled salt on the road is the advise to clean the trailer more often.

8.3 Minor servicing

Minor servicing must be carried out EVERY 250 WORKING HOURS (or at least once every 6 months) and includes the following parts of the machine:

1. Drive

- *Servicing the engine*
 - a Change the oil in the engine (*see chapter 3.2 "Engine" page.: 10*).
 - b Renew the oil filter, if fitted.
 - c Clean the air filter.
 - d Renew the fuel filter.
 - e Check the tension of the V-belt; increase tension, if necessary.
 - f Check the condition of the battery.

- g Check the torque of the attachment bolts for the engine; tighten them, if necessary.

For more information concerning the engine, you can find it in the book delivered with this machine.

2. Carriage:
Lubricate all mechanical moving parts in the system. Check that all nuts and bolts have been correctly tightened.
3. Pump system
 - *Cleaning the high-pressure control:*
When the high-pressure valve has been closed, the pressure gauge should not indicate any pressure. Similarly, if the spray gun is connected and closed, the pressure gauge should not indicate any pressure. If the pressure gauge does indicate a pressure, this implies a leakage in the system or that the one-way valve may be dirty or damaged. In which case stop the machine, unscrew the hose coupling and clean or replace the one-way valve. Also, check the condition of the O-ring and gasket.
Regularly clean the high-pressure control. Carefully remove all dirt! Proper maintenance will increase the service life of this part.
 - *Changing the pump oil:*
Change the pump oil in the high-pressure pump after every 1000 working hours (or at least once a year).

For more information concerning the pump, you can find it in the enclosure delivered with this machine.

8.4 Maintenance wheel bearings and wheel nuts.

After the first 50-100 km the wheel nuts must be checked on a good seat. If the seat is not good, pull the wheel nuts with a torque setting of 110Nm.
Aluminium rims: 100Nm!

After every 5000 km this must be repeated. Also, check the play on the bearings.
If there is any play on the bearings, we recommend advising our service department.

Supply the wheel nave after every 10000-km with new grease. Advise our service department. You can combine this with a thoroughly service maintenance of your machine.

8.5 Check the brake drums and the brakes.

Proceed as follows:

1. Disconnect the brake cables and hose and check that the brakes operate smoothly.
2. Rotate the brake drum in the normal direction and fasten the adjusting nut until the brake drum starts rubbing. Then rewind the nut approx. one third of a turn.
3. Connect the brake cables and fasten them on the brake horizon with a safety nut (when the hand brake has been operated, the brake horizon has to be below the main frame).
4. Attach the brake hose to the brake horizon and lock it by means of two safety nuts.

5. Tension the brake rod. Turn it clockwise until the hinged lever touches the brake cylinder without clearance.
6. Lock the brake rod by turning the lock nut against the fork of the brake rod.
7. Check the functioning of the brakes by means of a brake test.
8. Check the brakes on overheating (= brakes over tightened).
9. If the brakes become overheated, readjust the brake system once more.

8.6 Replacing lamps in the lighting unit



If the bulbs burn than these are hot and also their environment. Turn off the lights and let them cool down before replacing it.

- *Always turn off the lights and turn off the ignition before you replacing bulb lights .*
- *Never hold the glass bulbs with your fingers.*
- *Always replace a defective bulb with a new one of the same type.*
- *Before replacing a light bulb, check it if it's operates correctly.*
- *The back cover must be removed to place of the defected bulbs.*
- *Fog and reverse lamp can be replaced without removing the back cover!*

Proceed as follows:

1. Screw off the back cover at point A and also in some models at point B (2x).
2. Remove the back cover.
 - *Optionally, the connector plug can also be detach.*
3. Place the cover on the ground.
4. Replace the defective bulb(s).
5. Assemble everything in reverse sequence.

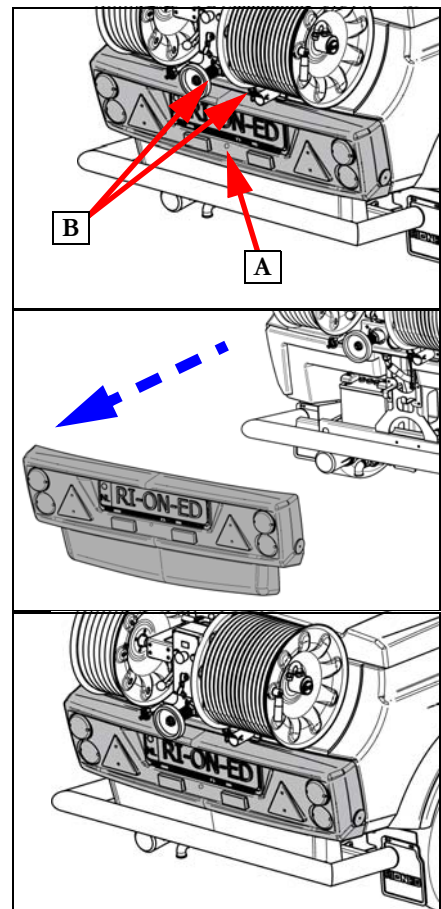

- *Ensure that the clamp plate is vertically stated before the cover is placed back.*

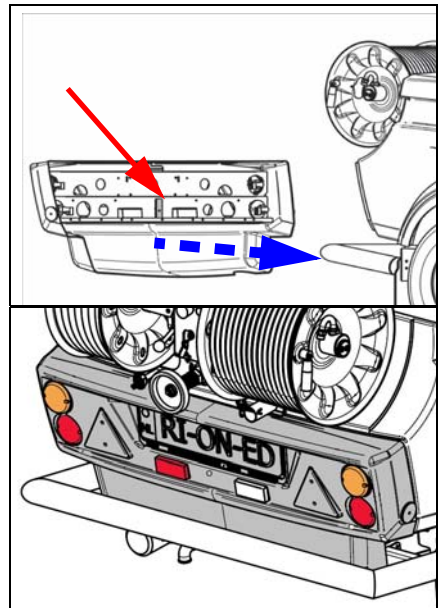

6. Check the operation of the rear lights.
 - *Indicators*
 - *Brake lights*
 - *Tail*
 - *Fog*
 - *Reversing light*
 - *License plate light*

8.7 Maintenance remote control

The remote is virtually maintenance free, however, the following points must be observed:

- *Protect the transmitter from water / moisture.*
- *Do not clean the transmitter and receiver with a pressure washer or other atomizing device.*
- *Charging and discharging the transmitter regularly.*
- *Disconnect the plug of the receiver regularly, otherwise it gets stuck with the result that there is interference.*

8.8 Hydraulic system

Renew oil



Important!

You have to renew the environment friendly hydraulic oil at least ones a year!

Only use oil HESTIA 46.

Order number Rioned 71-003-500-046

Check, every time before use, if the level of the oil is sufficient.

Proceed as follows:

1. Stop the machine.
2. Be aware that the machine is standing horizontal.
3. Take the dipstick (A) out of the oil tank (B).
4. Clean the dipstick with a tissue.
5. Put the dipstick into the oil tank.
6. Take the dipstick back and watch at the dipstick if the oil is between maximum a minimum (C).
7. Fill oil, if necessary.
8. Fasten the dipstick onto the oil tank.
9. Start the engine and let it turn for about 5 minutes.

10. Stop the machine and repeat point 2 until 8.

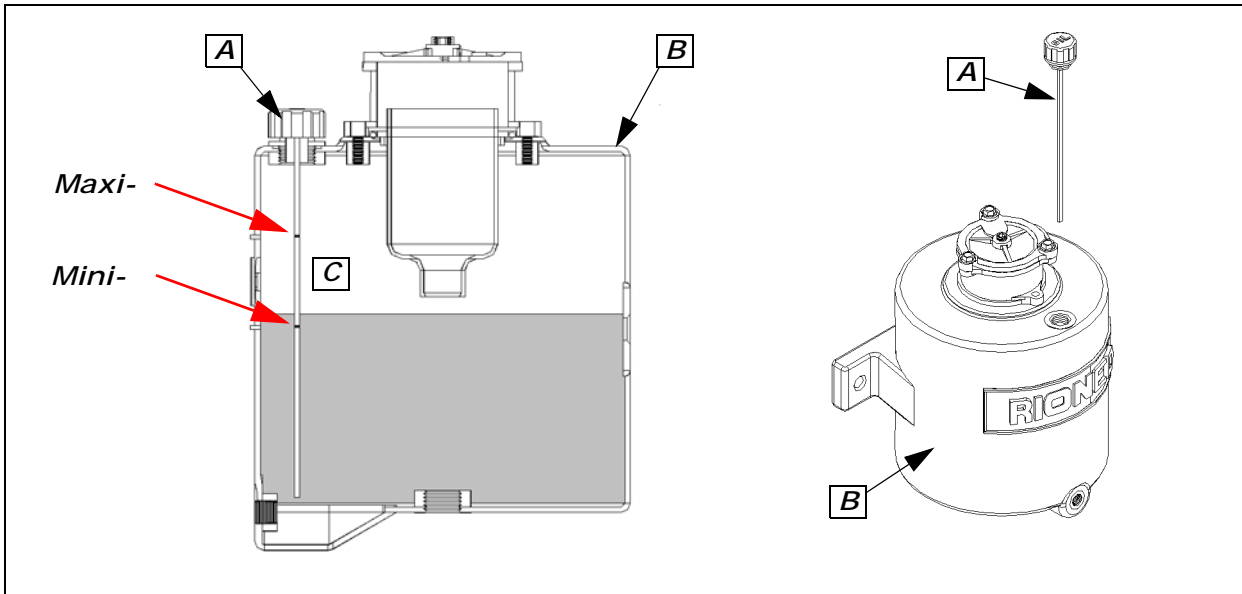

8.9 Extensive periodical maintenance

Have the high-pressure machine checked and maintained from time to time by the technical service of Rioned. In this way, long life and quality will be guaranteed.

8.10

Maintenance scheme

Interval

Check oil levels	:	Every time before use
Cleaning water filter	:	Every time before use and with strong pollution.
Cleaning carriage	:	weekly or with strong pollution.
Service engine	:	Every 250 working hours or at least once every six month
Lubricate moving parts	:	Every 250 working hours or at least once every six month
Cleaning pressure regulator	:	Every 250 working hours or at least once every six month
Wheel nuts	:	Pull every 5000 km
Wheel nave	:	After every 10.000 km supply with new grease
Renew pump oil	:	Every 1000 working hours or once a year
Renew oil hydraulic system	:	Once a year
Decalcify suction valves	:	Once a year
Decalcify pressure valves	:	Once a year
Puncture nozzle holes	:	Every 50 working hours

Replace all parts **immediately** if there is wastage or defect.

9 TROUBLESHOOTING

Failure	Reason	Solution
Engine does not start or stops abruptly.	Machine has run out of fuel	Add fuel
	Main or secondary fuse blown	Replace the defect fuse and restart engine. If problem repeats, contact your dealer
	Battery voltage too low.	Load or replace.
	Air in fuel line	Drain the engine
	Emergency stop activated	Turn the emergency stop in order to be able to start up again
The high-pressure pump does not produce the required pressure.	Water tank empty	Fill the water tank
	Supply valve to water filter closed.	Open the supply valve
	Water filter clogged.	Stop the machine and clean the water filter
	Air in high-pressure pump	Allow the machine to run a few minutes. The failure will normally disappear. If not, contact the service department of your dealer
	Suction valves blocked	Carefully loosen the valves and descale them, if necessary
	V-belt not sufficiently tightened	Tighten the V-belt; replace if necessary
	Suction valves worn out.	Contact the service department of your dealer.
Pressure varies.	Water level in tank too low	Stop the engine, refill the tank and restart engine
	Water supply valve not sufficiently opened	Open the supply valve completely
	Water filter clogged.	Stop the machine and clean the filter
	Pump sucks air	Stop the machine and check all hoses and couplings for leakage
	Nozzle clogged	Stop the machine and clean the nozzle (clean the nozzle holes)
	Pressure valves dirty or worn	Stop the machine. Check the condition of the pressure valves. Clean or replace them
	Pump gasket worn out	Stop the machine and replace gasket
	V-belts for the pump slip	Stop the machine and tighten the belts
	Ceramic plungers in the pump damaged	Contact your dealer
	Pressure control clogged or internally damaged.	Contact your dealer.

Failure	Reason	Solution
Hydraulic reel does not wind the hose	Handle not on right position	Put the handle into the right position
	Hydraulic tank almost empty	Refill the tank. Check the system on leakage
	Drive chain not sufficiently tighten	Tighten the chain
	Attachment bolt for control lever of hydraulic system loosened	fasten the bolt and put the lever into the correct position
	Working pressure set too low	Increase the working pressure, if possible
	Return filter hydraulic tank dirty	Switch off the machine and clean the return filter
	Hydraulic system damaged	Contact your dealer
No reaction by switching in transmitter	No current	Load battery
		Use new battery
		Control contact points on dirt and dust
		Check fuses
		Contact your supplier by repeating disturbances
	Transmitter is not on	Put button 0/1 to position I
	Transmitter out of reach from receiver	Put the machines closer on. Put transmitter closer
Warning signal after short working time	Battery empty / defect	Load or replace
	Battery not loaded or defect	Charge battery complete Check if the plug is connected and if the contact is on.
		Check if the charging works well
		Check battery points / clean it
		Use other battery
Transmitter indications are good but functions are not executed	Emergency stop pushed in	Unlock emergency stop
	Receiver has no current	Check / replace fuses
	No radio connection	Check functions of control lights
Certain functions are not executed	Receiver is faulty	Contact your supplier
	Interruption in electric circuit	Check all plugs. Plug in and push.
		Check control lights if functions are indicated
Insufficient braking effect	Excessive backlash in brake system	Re-adjust brake system by Rioned
	Brake linings not "run in"	Actuate hand-brake lever slightly; drive 2-3 kilo meters
	Brake linings glazed, oily or damaged	Replace brake shoes completely; clean braking areas in the brake drums
	Overrunning hitch hard to operate	Grease overrunning hitch
	Brake linkage is jammed or deformed	Eliminate cause
	Brake cables rusted or kinked	Replace cables

Failure	Reason	Solution
Brake reacts by jerks	Excessive backlash in brake system	Re-adjust brake system by Rioned
	Shock absorber of overrunning hitch defective	Replace shock absorber
	Backmat brake shoe is jammed in the brake shoe holder	Replace completely brake shoes with brake shoe holders
Trailer is braked unilaterally	Wheel brakes are actuated unilaterally	Re-adjust brake system by Rioned
	Brake lining not run in	Actuate hand-brake lever slightly; drive 2-3 kilo meters
	Brake glassy, soiled or damaged by oil	Replace brake shoes completely; clean braking areas in the brake drums
	Overrunning hitch is stiff	Grease overrunning hitch
	Backmat-blocks clamped in brake-shoe holders	Replace completely brake shoes with brake-shoe holders
Trailer is already braked when the accelerator pedal is released	Shock absorber of overrunning hitch defective	Replace shock absorber
Reverse driving hard to accomplish, or even impossible	Brake system adjusted too tightly	Re-adjust brake system by Rioned
	Cables pre-loaded	Re-adjust brake system by Rioned
	Backmat brake shoe is jammed in the brake shoe holder	Replace completely brake shoes with brake shoe holders
Braking action of hand-brake insufficient	Incorrect settings	Re-adjust brake system by Rioned
		Actuate hand-brake lever as far as possible
Wheel brakes get hot	Brake system incorrectly set	Re-adjust brake system by Rioned
	Overrunning hitch hard to operate	Grease overrunning hitch
	Brake linkage is jammed or deformed	Eliminate cause
	Brake cables rusty or kinked	Replace cables
	Backmat brake shoe is jammed in the brake shoe holder	Replace completely brake shoes with brake shoe holders
	Brake system adjusted too tightly	Re-adjust brake system by Rioned
	Wheel brakes dirty	Clean
	Reversing lever of overrunning hitch is jammed	Remove reversing lever, clean it and grease it with Molykote
	Spring-type actuator is pre-loaded in zero position; nut is turned too far	Re-adjust brake system by Rioned
	Handbrake lever not or only partially released	Set handbrake lever into zero-position
Ball coupling does not rest on ball	Coupling dirty the inside	Clean and grease thoroughly
	Ball of towing vehicle too big	Check ball diameter: The ball on the car must exceed 50 mm in diameter when new, and it must be $\varnothing 49,5$ mm. - If the ball diameter decreases to less than 49,0 mm, the ball has to be replaced. The ball must be perfectly spherical

10 AUXILIARIES

With this machine are some auxiliaries standard delivered.:

1. Two fork spanners (*Illustration 10.1*) for mount and dismount the spray gun.

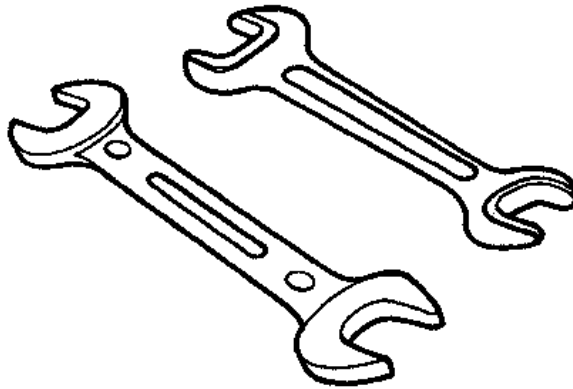

Illustration 10.1
Fork spanners.

2. Two nozzles (*Illustration 10.2*).
These nozzles are mounted at the end of the high-pressure hose. Connect always the O-ring on the screw thread of the high-pressure hose. Then screw the "nozzle open" on the high-pressure hose. After the un-glogging change "nozzle open" with "nozzle blind" to rinse.

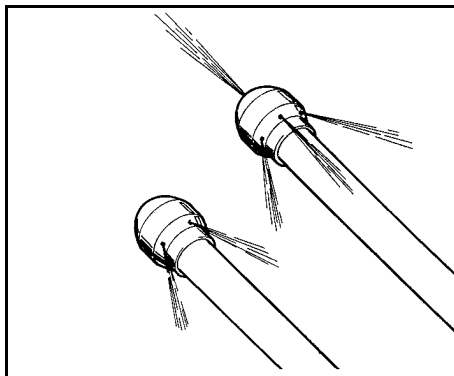

Illustration 10.2
Nozzle open and
blind.

3. One spray gun with lance(*Illustration 10.3*).
Mount the spray-gun at the end of the high-pressure hose. It is used to spray facades, pavements and floors clean. Connect always the O-ring over the screw thread of the high-pressure hose. Mount the spray-gun on them high-pressure hose by means of the fork spanners.

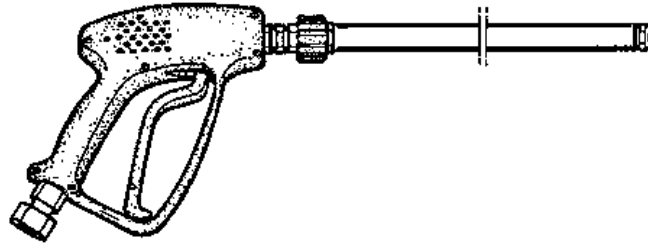

Illustration 10.3
Spray gun with lance

4. One users manual
5. One engine book
6. One pomp enclosure

11 APPENDIX

11.1 EC declaration Of Conformity For Machinery

RIOR B.V. / RIONED
Centaurusweg 45, Tilburg, The Netherlands,

Herewith declares that:

High pressure device RIONED FlexJet/FlexJet+,

- is in compliance with the Machinery Directive (2006/42/EC and 2007/46/EC);
- is in conformity with the provisions of the following other EEC directives:
2014/30/EC
- the following harmonized standards have been applied:

NEN-EN-ISO 12100:2010, NEN-EN-ISO 13850:2015,
NEN-EN-ISO 13857, NEN-EN-349, EN 60204-1

Tilburg, The Netherlands, Friday 19 February 2016

A handwritten signature in black ink, appearing to read 'J. Pieters', written over a horizontal line.

J. Pieters
Managing Director

11.2 Contact sales representatives

EXPORT

D.Maas / H. de Laat
Area Sales Manager, Rior B.V. / Rioned
info@rioned.com
www.rioned.com
Centaurusweg 45
5015 TC Tilburg
Tel.: +31 13-547 91 00

11.3 After Sales Service

Rioned
Centaurusweg 45
5015 TC Tilburg
Tel.: +31 13-547 91 51

11.4

Dimension FlexJet

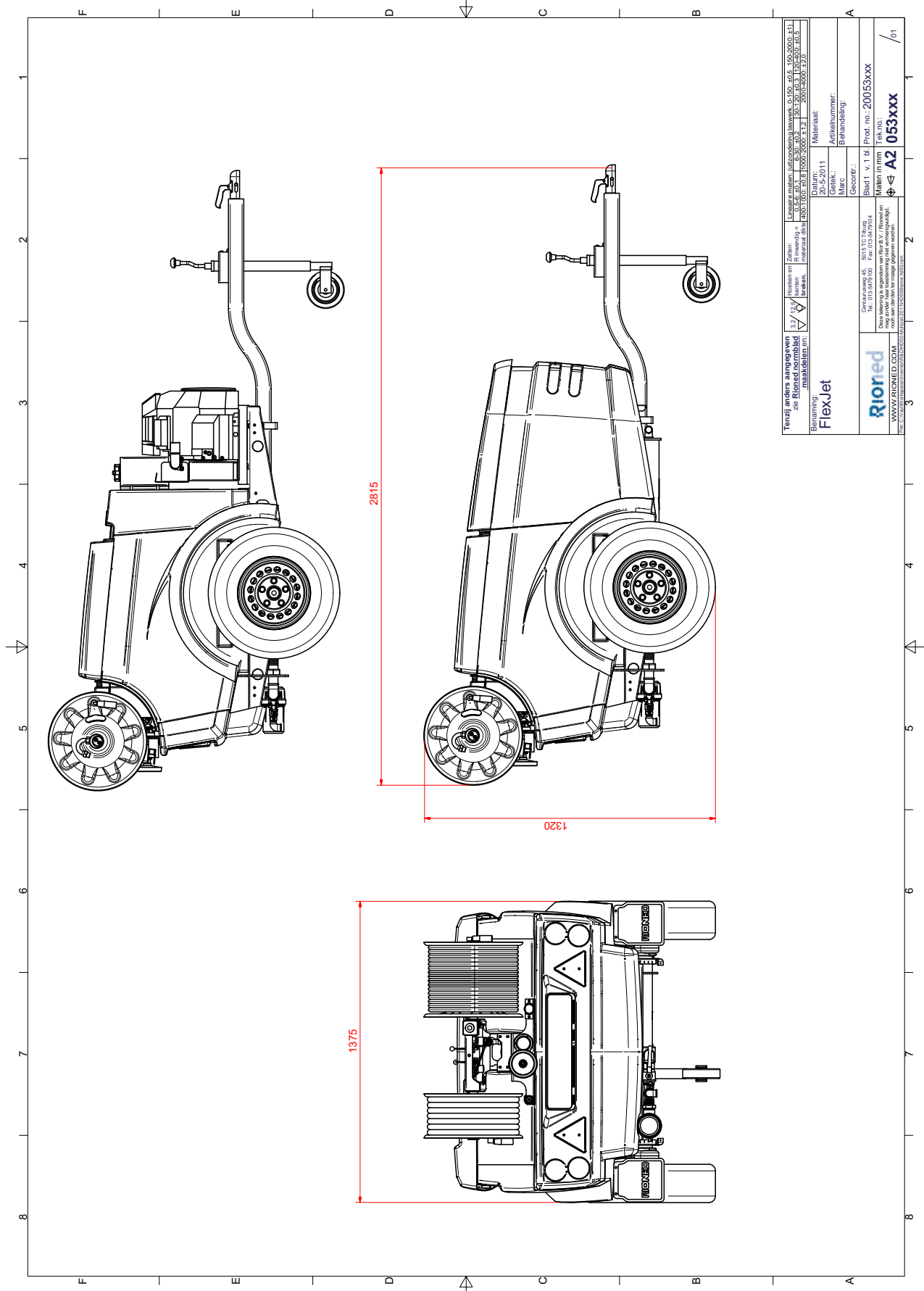

Tehnikai andrs angngewen 246 Riored nomblid markshien: en		Hoeken van kanten kanten kanten		Hoeken van kanten kanten kanten		Hoeken van kanten kanten kanten		Hoeken van kanten kanten kanten	
Riored FlexJet		2013 LC 1800 2013 LC 1800 2013 LC 1800		2013 LC 1800 2013 LC 1800 2013 LC 1800		2013 LC 1800 2013 LC 1800 2013 LC 1800		2013 LC 1800 2013 LC 1800 2013 LC 1800	
Riored FlexJet		2013 LC 1800 2013 LC 1800 2013 LC 1800		2013 LC 1800 2013 LC 1800 2013 LC 1800		2013 LC 1800 2013 LC 1800 2013 LC 1800		2013 LC 1800 2013 LC 1800 2013 LC 1800	
Riored FlexJet		2013 LC 1800 2013 LC 1800 2013 LC 1800		2013 LC 1800 2013 LC 1800 2013 LC 1800		2013 LC 1800 2013 LC 1800 2013 LC 1800		2013 LC 1800 2013 LC 1800 2013 LC 1800	

Resultaten geluidsmetingen ter bepaling van optredende geluidsniveaus rondom de machine op de werkplek.

Datum: 11-10-2011
 Gemeten door: Ronald Kurvers
 Meetinstrument: CEL-269 Digitale Integrenderende Geluidsniveaumeter volgens IEC 651 type 2, ANSI S1.4 type 2A en BS 5889 type 2
 Impuls geluidsniveaumeter volgens IEC 651 type 2I
 Integrenderende geluidsniveaumeter volgens IEC 804, BS 6698
 Dynamisch bereik: 70 dB
 Nauwkeurigheid: ± 1 dB (onder referentiecondities)
 Frequentiebereik (+0,5/-3 dB): 10 Hz tot 25 kHz voor alle bereiken

Meetbereik:

Instelling	Frequentieweging	Weergavenbereik	Bereik primaire lineariteit (IEC 651)
A LO (laag)	A	30-100 dB-33 - 86 dB	
A HI (hoog)	A	65-135 dB	68 - 121 dB
C LO (laag)	C	30-100 dB	33 - 86 dB
C HI (hoog)	C	65-135 dB	68 - 121 dB

Richtgevoeligheid:
 Binnen de grenzen van IEC 651



Microfoontype:
 Elektret (CEL 1/2), voor gecombineerd, circa 10 mV/Pa, vast bevestigd aan meter. De microfoon voldoet aan de geldende normen (type 2) voor zowel vrije veldmetingen als omringingsveldmetingen.

Instellingen geluidsmeter tijdens het meten.

- Mode: Leq
- Range: A HI
- Response: (F)ast
- Controls: 4 Volt
- Gebruik windbol:
- Meter gekalibreerd voor meting:

Gemeeten machine: FlexJet
 Motor: Honda
 Pomp: Speck P30
 Meetposities: Alle meetpunten bevinden zich op "gemiddelde oorhoogte": 1,60 m boven de grond.

De metingen zijn verricht op de aangegeven afstand van een pand, hetgeen representatief mag worden genoemd voor de te verwachten werkomstandigheden bij gebruik van deze machine.

De bedieningsplaats van de machine is globaliseerd tussen meetpunt E en meetpunt F.

Meetresultaten:

geluidsniveau (dB)

Omgevingsgeluid met machine uitgeschakeld		65	
Positie	Omschrijving	Stationair	Werkdruk belast
A	Rechts, op 2 m afstand van de machine.	67.2	88.8
B	Voor, op 2 m afstand van de machine.	71.3	93.0
C	Links, op 2 m afstand van de machine.	66.3	89.0
D	Achter, op 2 m afstand van de machine.	66.2	88.5
E	Bedieningsplek links	65.4	86.9
F	Bedieningsplek rechts	65.7	87.7
G	Rechts, op een straal van 7 m hart machine	60.1	81.3
H	Voor, op een straal van 7 m hart machine	62.2	84.7
I	Links, op een straal van 7 m hart machine	60.1	82.8
J	Achter, op een straal van 7 m hart machine	56.8	80.2

Opmerking: vo37427

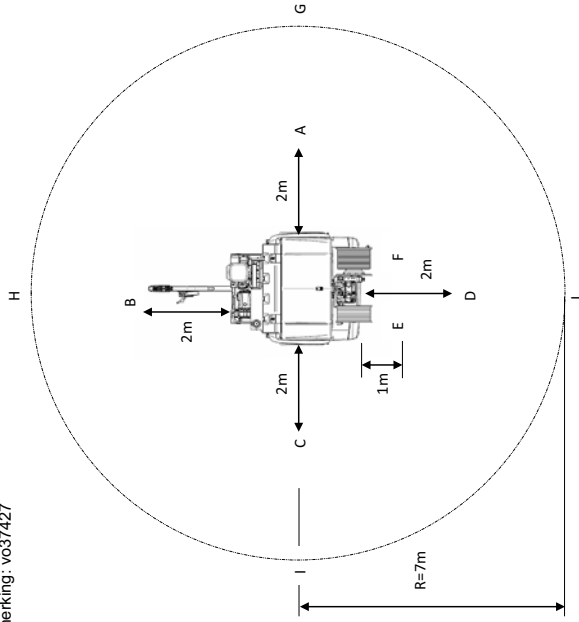

Resultaten geluidsmetingen ter bepaling van optredende geluidsniveaus rondom de machine op de werkplek.

Datum: 11-10-2011
 Gemeten door: Marc Stoelhout
 Meetinstrument: CEL-269 Digitale Integreerends Geluidsniveaumeter volgens IEC 651 type 2
 Ingevoerde geluidsniveaumeter volgens IEC 651 type 2
 Dynamisch bereik: volgens IEC 804, BS 6898 70 dB
 Nauwkeurigheid: ± 1 dB (onder referentiecondities)
 Frequentiebereik (+0,5/-3 dB): tenminste 10 Hz tot 25 KHz voor alle bereiken

Meetbereik:

Instelling	Frequentieweging	Weergavenbereik	Bereik primaire lineariteit (IEC 651)
A LO (laag)	A	30-100 dB	33 – 86 dB
A HI (hoog)	A	65-135 dB	68 – 121 dB
C LO (laag)	C	30-100 dB	33 – 86 dB
C HI (hoog)	C	65-135 dB	68 – 121 dB

Richtgevoeligheid:
 Binnen de grenzen van IEC 651

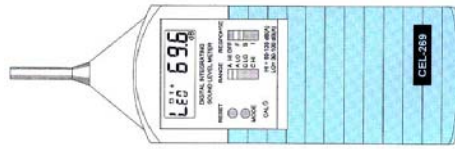

Microfoontype:
 Elektret (CEL), 1/2", voor gepolariseerd, circa 10 mV/Pa, vast bevestigd aan meter. De microfoon voldoet aan de geldende normen (type 2) voor zowel vrije veldmetingen als rondomgevoelige metingen.

Instellingen geluidsmeter tijdens het meten.

- Mode: Leq
- Range: ALO
- Response: (F)ast
- Controls
- Batterijspanning: 4 Volt
- Gebruik windbol:
- Meter gekalibreerd voor meting:

Gemeten machine: FlexJet+
 Motor: Honda QXE 620 20 PK
 Pomp: Speck P30

Meetposities:
 Alle meetpunten bevinden zich op "gemiddelde oorhoogte": 1,60 m boven de grond.
 De metingen zijn verricht op de aangegeven afstand van een pand, hetgeen representatief mag worden genoemd voor de te verwachten werkomstandigheden bij gebruik van deze machine.
 De bedieningsplaats van de machine is gelokaliseerd tussen meetpunt E en meetpunt F.

Meetresultaten:

Omgevingsgeluid met machine uitgeschakeld		58	
Positie	Omschrijving	Stationair	Werkdruk belast
A	Rechts, op 2 m afstand van de machine.	64.4	85.5
B	Voor, op 2 m afstand van de machine.	67.0	86.1
C	Links, op 2 m afstand van de machine.	66.4	86.8
D	Achter, op 2 m afstand van de machine.	65.2	84.8
E	Bedieningsplek links	68.4	86.3
F	Bedieningsplek rechts	68.0	86.6
G	Rechts, op een straal van 7 m hart machine	64.0	79.7
H	Links, op een straal van 7 m hart machine	64.4	79.6
I	Voor, op een straal van 7 m hart machine	64.1	79.6
J	Achter, op een straal van 7 m hart machine	61.0	79.0

Opmerking: vo26235

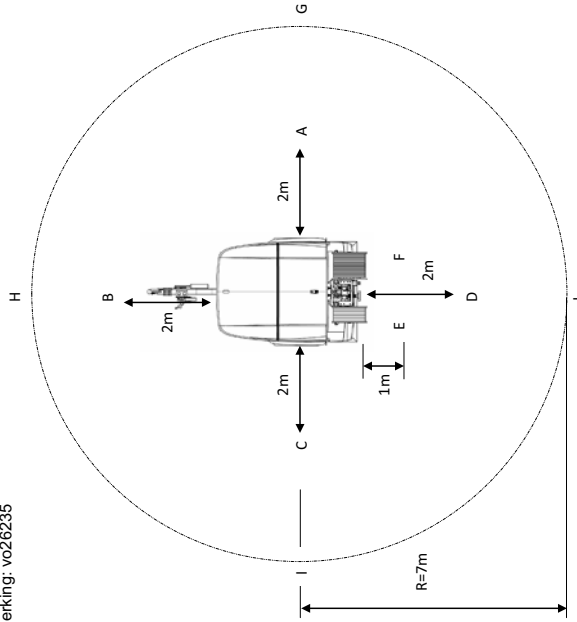



Setting the standard

EC CERTIFICATE OF CONFORMITY
 COMPLETE VEHICLES
 PART I

The undersigned:	Twan Schellekens
Function:	Manager Customer Service
hereby certifies that the vehicle	
0.1. Make ((Trade name of manufacturer):	Rioned
0.2. Type:	FLEXJET+
Variant:	A
Version:	-
0.2.1. Commercial name:	FLEXJET+
0.4. Vehicle category:	O2
0.5. Name and address of manufacturer:	Rioned Centrusweg 4... 57... Tilburg (Netherlands)
0.6. Location of the statutory plates:	ft, left beam and axle
Method of attachment:	glued
Location of the vehicle identification number:	right, right beam behind axle
0.9 Name and address of the manufacturer's representative:	-
0.10 Vehicle identification number:	330017009339
conforms in all respects to the type described in approval:	e4*2007/46*0514*01
issued on:	17/11/2014
and can be permanently registered in the States having right/	
metric/imperial units for the speedometer.	
Place:	Tilburg
Date:	24/01/2018
Signature:	

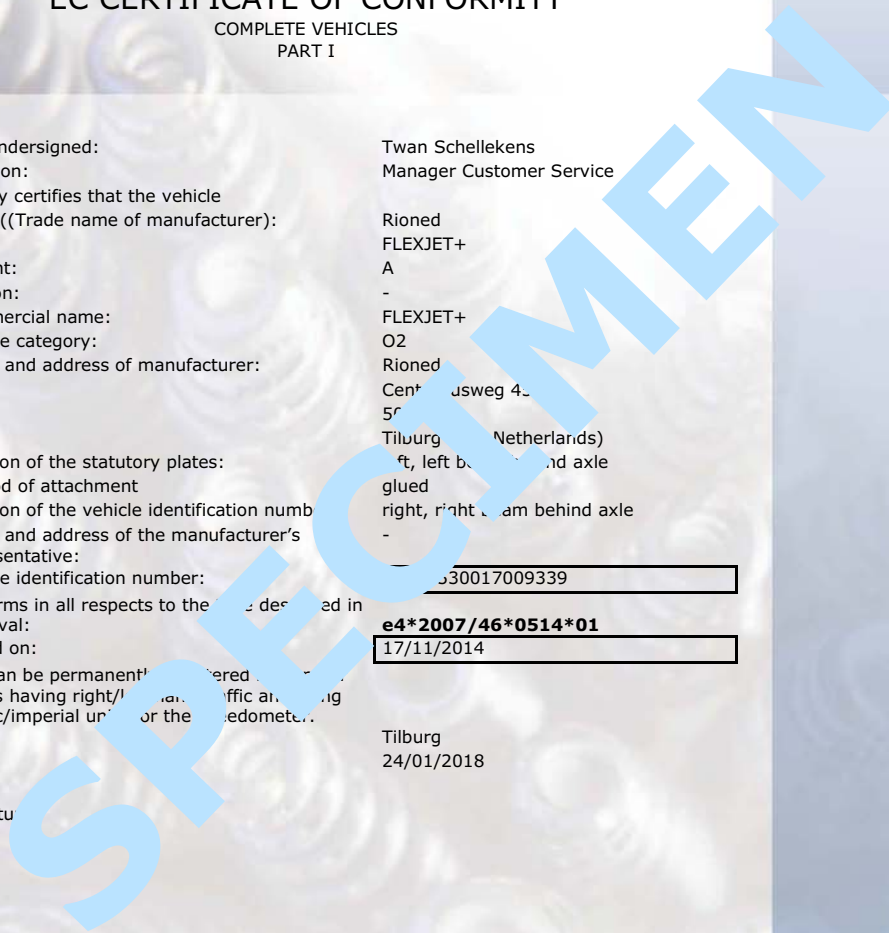

General construction characteristics

1.	Number of axles: ... and wheels: ...	1 / 4
1.1	Number and position of axles with twin wheels:	
Main dimensions		
4.	Wheelbase:	7220 mm
4.1	Axle spacing:	
5.	Length:	14100 mm
6.	Width:	14100 mm
7.	Height:	1330 mm
10.	Distance between the centre of the coupling device and the rear end of the vehicle:	7140 mm
11.	Length of the loading area:	- mm
12.	Rear overhang:	920 mm
Masses		
13.	Mass of the vehicle in running order:	420 kg
13.1	Distribution of this mass amongst the axles:	390 kg
13.2	Actual mass of the vehicle:	420 kg
16.	Technically permissible maximum masses:	
16.1	Technically permissible maximum laden mass:	1200 kg
16.2	Technically permissible mass on each axle:	1350 kg
16.3	Technically permissible mass on each axle group:	-
19.	Technically permissible maximum static mass on the coupling point of a semi-trailer or centre-axle trailer:	100 kg
Maximum speed		
29.	Maximum speed :	140 km/h
Axles and suspension		
30.1	Track of each steered axle:	1200 mm
30.2	Track of all other axles:	-
31.	Position of retractable axle(s):	-
32.	Position of loadable axle(s):	-
34.	Axle(s) fitted with air suspension or equivalent:	no
35.	Tyre/wheel/rim combination:	155R13 C, 89/91N, 4½x13H2
Brakes		
36.	Trailer brake connections:	mechanical
Bodywork		
38.	Code for bodywork:	DC
Coupling device		
44.	Approval number or approval mark of coupling device:	E1-55R-01-0159
45.1	Characteristics values:	D:14,95kN / V:- / S:120kg / U:-
Miscellaneous		
50.	Type-approved according to the design requirements for transporting dangerous goods: <u>yes/class(es):</u>/	no
51.	For special purpose vehicles: designation in accordance with Annex II Section 5:	-
52.	Remarks:	-

12 INDEX

A

accessories 7
antifreeze 35
antifreeze tank 35
attention 26, 41

C

caution 29
change battery at transmitter
..... 48
copyright 2

D

decalcify pressure valves 56
decalcify suction valves .. 56

E

ear protector 5
emergency stop 5, 39
engine start 37
engine stop 37
exposure 6

F

failure 6
flexmote 27, 29, 31, 32

G

general security signs 5
gloves 5

H

hestia 46 54
hitch 17

I

injuries 7

L

looking glasses 5

M

main parts 13
mark 32, 51
maximum water temperature
..... 20
mechanical failures 6

O

oil level 51
original spare parts 7

P

pin 17
pressure regulator 5
protection facilities 7
protection looking glasses .5
puncture nozzle holes 56

Q

qualifications 6

R

renew oil 54
responsibility 6
responsible 5
riomote 27, 28, 30
rioned 2, 7

S

safety break handle 17
safety cable 17
safety lock 17
sales managers 64
security covers 5
servicing the engine 51
sharp objects 29
signal lamp 37
special repair couplings ... 29
start de machine 23
start spraying 37
stop spraying 28, 37
stop working 31

T

technical specification 48
the machine is built by 3
tow bar 17
traffic 29
transmitter 58
trouble shooting 47

W

warning 18
warning signal 58
warranty 7
water tight clothes 5
weight 9

