

# CityJet user manual

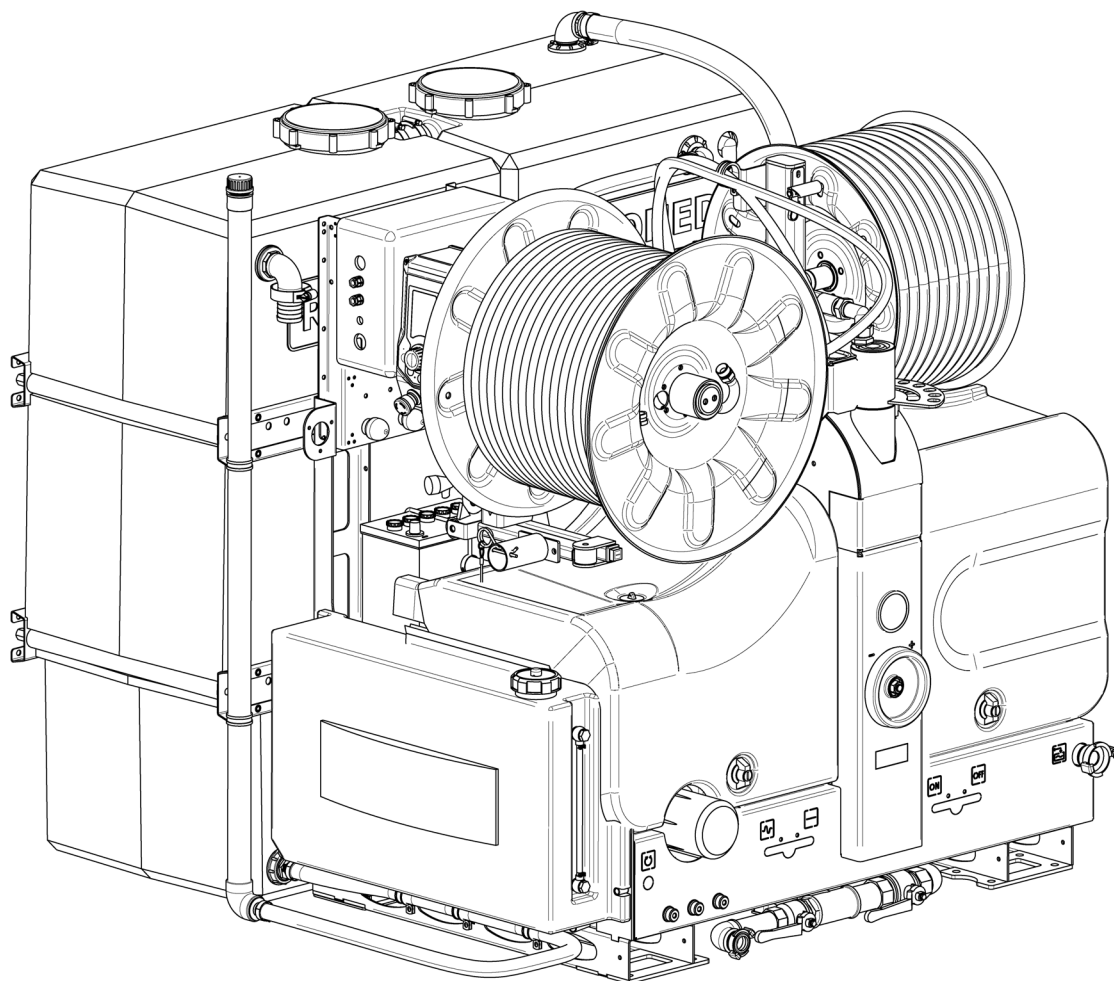

**Rioned**

## **Operating and maintenance manual**

Identification number: vo . . . . .

Serial number: . . . . .

Type **CityJet**

Year of manufacture: . . . . .

### **Manufacturer:**

Rioned

Centaurusweg 45

5015 TC Tilburg

P.O. Box 5070

NL-5004 EB Tilburg

Tel. no.: +31 13-5479100

E-mail: [info@rioned.com](mailto:info@rioned.com)

Internet: [www.rioned.com](http://www.rioned.com)

For information about adjustments, maintenance or repairs not contained in this user manual, contact Rioned.

Original user manual

Publication date: 1/2/19

Version: 21

All rights reserved. No part of this publication may be reproduced and/or made public by means of printing, photocopying, microfilm or any other means whatsoever without the prior written permission of Rioned.

Rioned reserves the right to make changes to parts at any time, without providing prior or direct notification to the buyer. The content of this user manual may also be changed without prior notification.

# Preface

This user manual is intended for the professional user. It is intended to enable the user to operate the machine and must always be kept with the machine.

The photographs and drawings in the manual are intended to support the text.

In this user manual you will first find an introduction that describes, among other things, the intended purpose of the machine. Then there is an explanation of how the machine is constructed and how it works in general. This is followed by an overview of the most important safety aspects.

Then the best way to start up and operate the machine is explained. The standard functions and additional functions are described separately. The information in the Maintenance section allows you to perform simple maintenance work yourself. Troubleshooting tips to help you correct minor malfunctions yourself are also provided.

Finally, at the end of this user manual you will find an index to help you quickly find information and a number of annexes containing, among other things, Rioned's contact details.



# Table of contents

<b>Preface .....</b>	<b>3</b>		
<b>Table of contents .....</b>	<b>5</b>		
<b>1 Introduction .....</b>	<b>7</b>		
<b>2 Description and principle of operation .....</b>	<b>9</b>		
2.1 Introduction .....	9		
2.2 Machine .....	9		
2.2.1 Design and principle of operation .....	9		
2.2.2 Symbols on pressure gauge, pressure regulator and valve controls .....	15		
2.2.3 Accessories .....	15		
2.3 eControl+ .....	16		
2.3.1 Design and principle of operation .....	16		
2.3.2 eControl+ .....	17		
2.3.3 Lightbar .....	18		
2.3.4 Navigation bullets .....	18		
2.3.5 Functions and symbols .....	22		
2.3.6 Tachometer .....	23		
2.4 Riomote control (option) .....	23		
2.4.1 Introduction .....	23		
2.4.2 Preparation for use .....	24		
2.4.3 Replacing the battery .....	26		
2.4.4 5-channel Riomote control .....	27		
2.4.5 7-channel Riomote control .....	28		
2.4.6 9-channel Riomote control .....	29		
<b>3 Safety .....</b>	<b>31</b>		
3.1 Introduction .....	31		
3.2 General danger symbol .....	31		
3.3 Working safely .....	31		
3.4 Dangers of non-compliance with safety instructions .....	31		
3.5 Use only by authorized personnel .....	32		
3.6 Bystanders .....	32		
3.7 Restrictions on use .....	32		
3.8 Thunderstorm .....	32		
3.9 Spraying .....	32		
3.10 Spray break .....	33		
3.11 Sewer gases .....	33		
3.12 Water tank .....	33		
3.13 Emergency stop .....	33		
3.14 Levers and valves .....	33		
3.15 Personal protective equipment .....	33		
3.16 Water discharge .....	34		
3.17 Other machine safety provisions .....	34		
3.17.1 Introduction .....	34		
3.17.2 Pressure regulator .....	34		
3.17.3 Protective covers .....	34		
3.18 Safety sticker .....	35		
<b>4 Operation: standard functions .....</b>	<b>37</b>		
4.1 Introduction .....	37		
4.2 Checks before departure .....	37		
4.3 Preparations at the workplace .....	38		
4.3.1 Preparing the vehicle .....	38		
4.3.2 Before starting .....	38		
4.3.3 Workstations .....	39		
4.4 Starting the engine .....	40		
4.4.1 Starting the engine with the eControl+ .....	40		
4.4.2 Starting the engine with the Riomote control .....	42		
4.4.3 Unblocking a sewer .....	43		
4.4.4 Spray nozzle warning .....	43		
4.4.5 Preparations for spraying .....	43		
4.4.6 Starting spraying .....	44		
4.4.7 Stopping spraying .....	45		
4.4.8 Handling the high pressure hose .....	46		
4.5 Cleaning a wall, terrace or floor .....	46		
4.5.1 Warnings for spray gun .....	46		
4.5.2 Preparations for spraying .....	46		
4.5.3 Pressurizing the system .....	47		
4.5.4 Starting spraying .....	47		
4.5.5 Depressurizing the system .....	47		
4.6 Ending the work .....	48		
4.6.1 Cleaning up, securing and draining .....	48		
4.6.2 Additional steps during freezing temperatures .....	48		
<b>5 Operation: extra functions .....</b>	<b>51</b>		
5.1 Introduction .....	51		
5.2 Pulsator .....	51		
5.2.1 Introduction .....	51		
5.2.2 Manual operation pulsator .....	51		
5.2.3 Starting the pulsator with the eControl+ .....	51		
5.2.4 Stopping the pulsator with the eControl+ .....	52		
5.2.5 Setting the speed with the eControl+ when the pulsator is switched on .....	53		
5.2.6 Starting the pulsator with the Riomote control .....	54		
5.2.7 Stopping the pulsator with the Riomote control .....	54		
5.3 Electric swivel arm latch .....	55		
5.4 Reel .....	56		
5.4.1 Safety .....	56		
5.4.2 Hydraulically reeling high pressure hose in/out .....	56		
5.4.3 Manually reeling high pressure hose out .....	57		
5.4.4 Hose guide .....	57		
5.4.5 Reeling high pressure hose in/out with the eControl+ .....	58		
5.4.6 Manually reeling out high pressure hose controlled by eControl+ .....	60		
5.4.7 Reeling in/out with the Riomote control .....	61		
5.5 Hose meter counter eControl+ .....	62		
5.5.1 Introduction .....	62		
5.5.2 Activating the eControl+ .....	62		
5.5.3 Switching the hose counter on and off .....	62		
5.5.4 Resetting hose counter to 0 metres .....	63		
5.5.5 Switching between 'metres' and 'feet' .....	63		
5.6 Electronic water level control .....	64		
5.7 Suction venturi .....	64		
5.8 Eco mode eControl+ .....	65		
5.8.1 Introduction .....	65		
5.8.2 Switching eco mode on and off .....	65		
5.8.3 ECO Start/Stop .....	67		
5.8.4 ECO Stop .....	67		
5.9 Management function eControl+ .....	68		

<b>6</b>	<b>Maintenance.....</b>	<b>71</b>	<b>7</b>	<b>Malfunctions .....</b>	<b>77</b>
6.1	Safety instructions.....	71	7.1	Fault messages, eControl+.....	77
6.2	Making changes to the machine.....	71	7.1.1	Emergency stop .....	77
6.3	Maintenance schedule .....	71	7.1.2	Engine temperature too high .....	77
6.4	Removal/installation of protective covers.....	73	7.1.3	Heat exchanger temperature too high .....	77
6.5	Maintenance before the work .....	73	7.1.4	Hydraulic oil temperature too high.....	78
6.5.1	Check oil levels .....	73	7.1.5	Hydraulic oil level too low .....	78
6.5.2	Clean water filter.....	74	7.1.6	Coolant level too low .....	79
6.5.3	Check high pressure hose and other hoses .....	74	7.1.7	Battery voltage too low .....	79
6.5.4	Maintenance of remote control .....	74	7.1.8	Water level too low.....	79
6.6	Weekly maintenance .....	74	7.1.9	Water level too high .....	80
6.7	Maintenance every 50 hours of operation.....	74	7.1.10	Troubleshooting.....	81
6.8	Maintenance every 250 hours of operation or at least once every six months.....	75	<b>8</b>	<b>Index .....</b>	<b>87</b>
6.8.1	Lubricate moving parts .....	75	<b>9</b>	<b>Attachments .....</b>	<b>91</b>
6.8.2	Clean pressure regulator.....	75	Annex 1	EC declaration of conformity.....	92
6.9	Maintenance every 1000 hours of operation or at least once a year.....	75	Annex 2	Type plate .....	93
6.9.1	Change hydraulic oil.....	75	Annex 3	Dimensions .....	94
6.9.2	Clean suction valves of high pressure pump .....	75	Annex 4	Technical specifications.....	95
6.9.3	Clean pressure valves of high pressure pump .....	76	Annex 5	Contact details.....	97
6.9.4	Major scheduled maintenance .....	76			

# 1 Introduction



Congratulations on the purchase of the *CityJet*! The *CityJet* is intended for unblocking sewers and cleaning walls, terraces and floors. With correct use, this machine will serve you well for years to come.

Read this user manual carefully before putting the machine in service, and always use the machine in accordance with the instructions. If problems occur, consult Rioned.

This user manual contains all the information about operation and maintenance. If the machine is set up and operated correctly and regularly maintained, we provide the warranty specified in the general terms and conditions of delivery. The warranty is void and your safety and that of people in the vicinity cannot be guaranteed if the operating and maintenance instructions are not followed or are not followed correctly.

The following requirements must be met when working with the machine:

## **Use in enclosed spaces:**

- > When working in an enclosed space, the space must be well ventilated.
- > Make sure the combustion gases are properly discharged. Prevent CO poisoning!

## **Spray site:**

ALWAYS follow the instructions below for the spray site:

- > Demarcate the site clearly. The minimum distance between the spray site and the demarcation is six metres.
- > Remove anything within the demarcation that is not firmly anchored.
- > NEVER spray from an unstable location. Examples: ladder, boat, or hanging scaffolding.
- > If it is necessary to use artificial lighting, ALWAYS use waterproof light fixtures.





## 2 Description and principle of operation

### 2.1 Introduction

In this chapter we first briefly describe the operation, the main components and the symbols used for the machine and the accompanying accessories. You will then find a description of the machine's control units in the '*eControl+*' and '*Riomote control*' sections.

### 2.2 Machine

#### 2.2.1 Design and principle of operation

The engine drives the high-pressure pump via a V-belt. The high pressure pump draws water from the water tank via the water filter and pressurizes it. The water then exits the machine at high pressure via the high pressure hose on the reel.

The machine consists of the following parts:

- |   |   |
|---|---|
| 1. High pressure hose on reel                     | 19. Fuel tank                                 |
| 2. Filling reel                                   | 20. Locks, covers                             |
| 3. Securing end of filling hose                   | 21. Drain valve, water filter                 |
| 4. Pump cover                                     | 22. Connection, drain hose                    |
| 5. Engine cover                                   | 23. Reel latch                                |
| 6. Filling valve, water tank                      | 24. Latch, swivel arm                         |
| 7. 12 V connection                                | 25. Pressure gauge                            |
| 8. Spray nozzles on holders                       | 26. Pressure regulator                        |
| 9. Battery  | 27. Water filter                              |
| 10. Water tank                                    | 28. Supply valve, water filter                |
| 11. Supply valve, filling reel                    | 29. Indicator, water level                    |
| 12. eControl+                                     | 30. High pressure pump                        |
| 13. Hose guide                                    | 31. Oil tank, hydraulic system                |
| 14. High pressure valve                           | 32. Engine                                    |
| 15. Navigation knob, eControl                     | 33. Receiver, Riomote control (option)        |
| 16. Button, emergency stop                        | 34. Battery charger, Riomote control (option) |
| 17. Lever, control slider, hydraulic reel control | 35. Pulsator on/off                           |
| 18. Hose holder                                   |   |

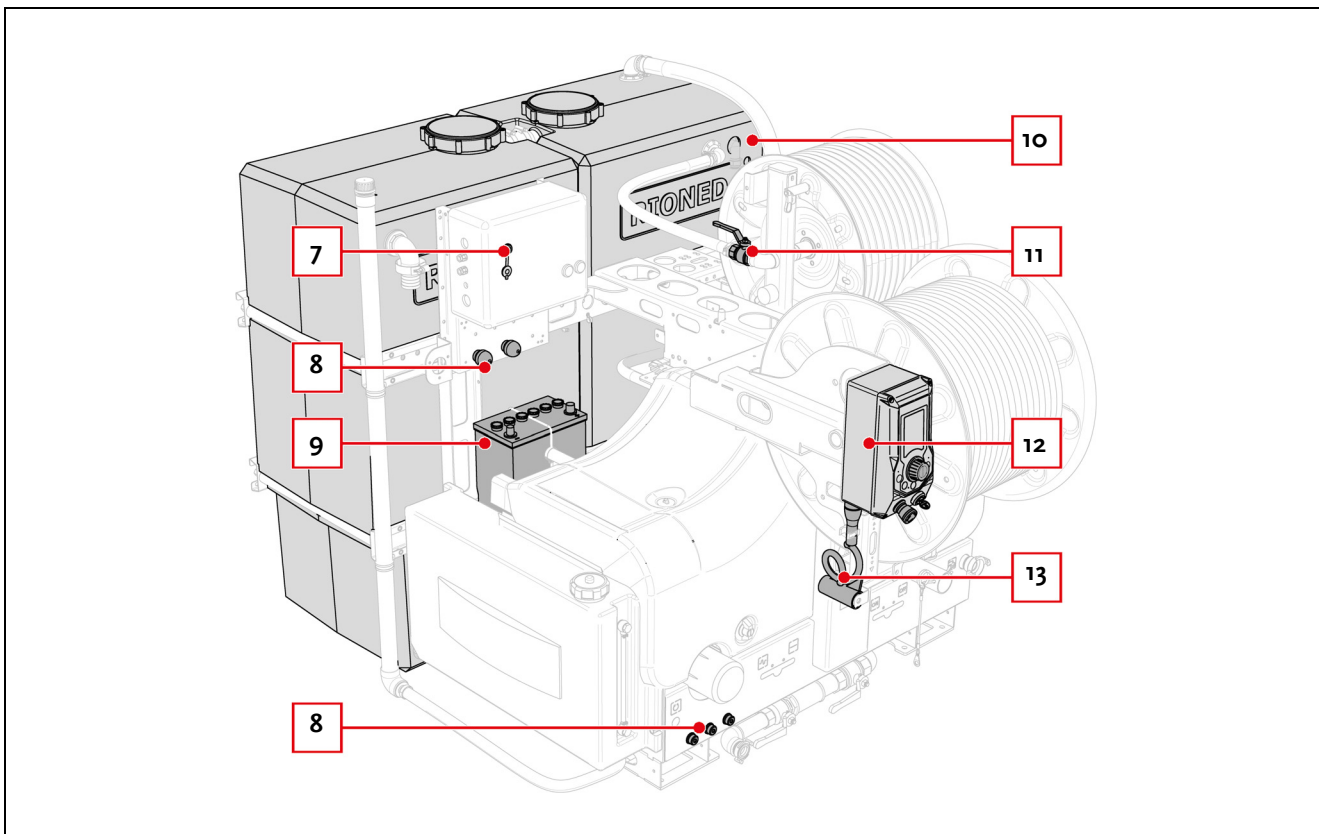
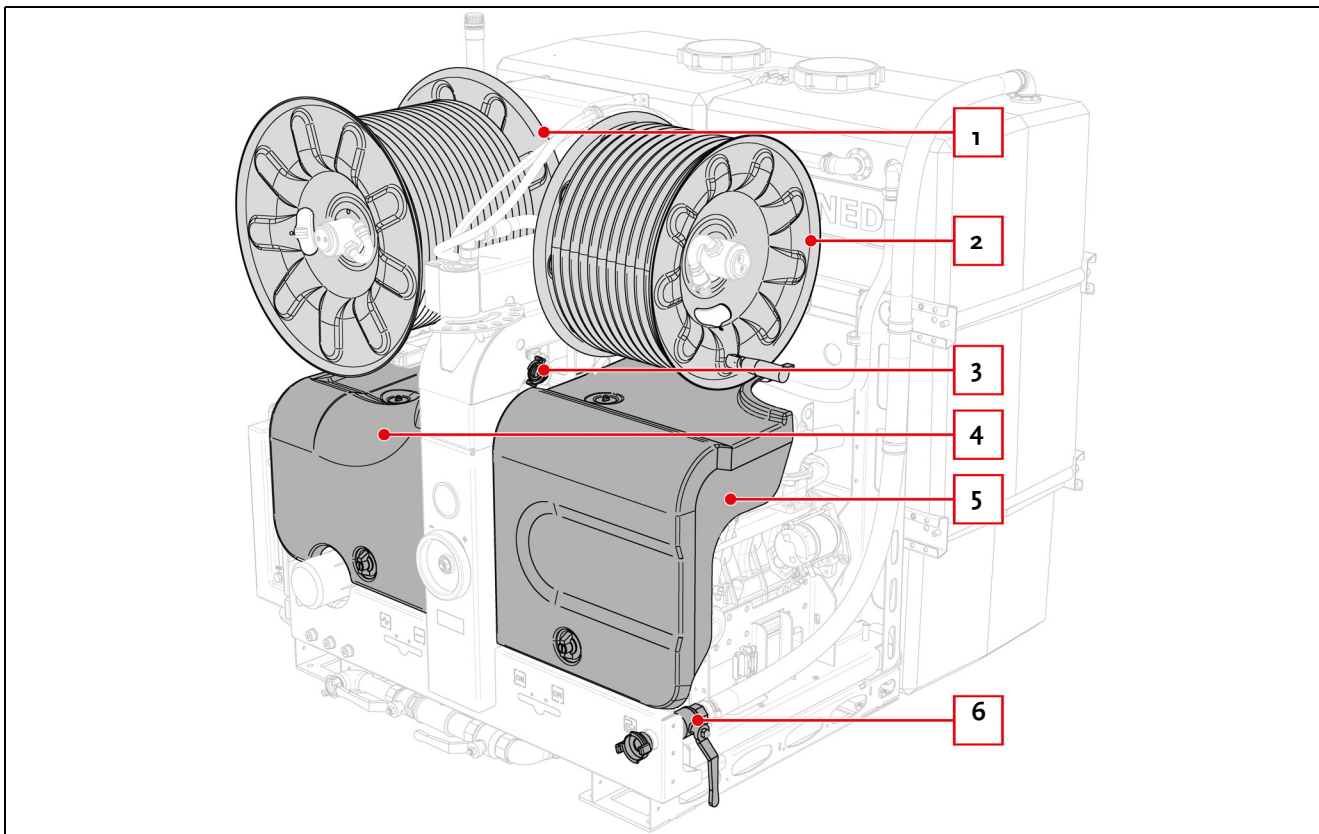

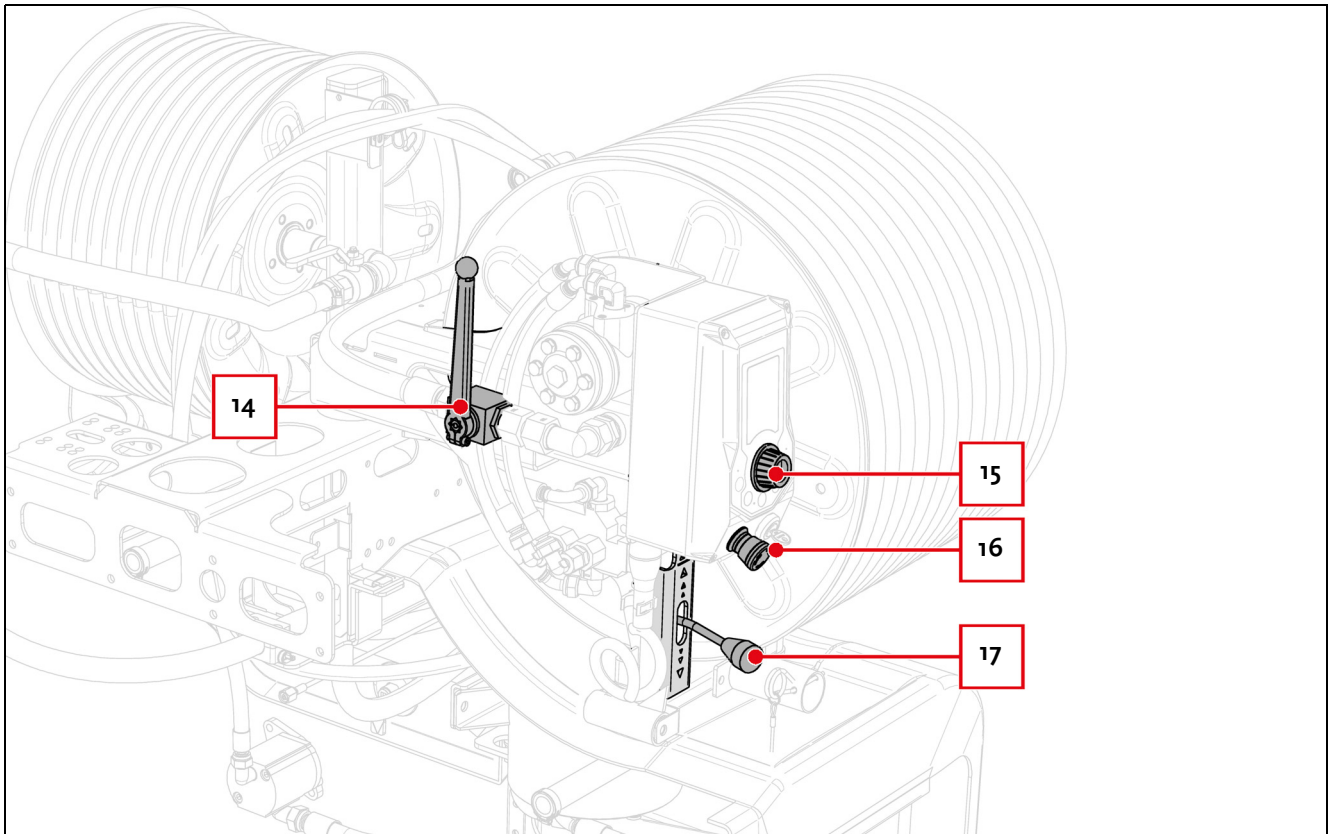

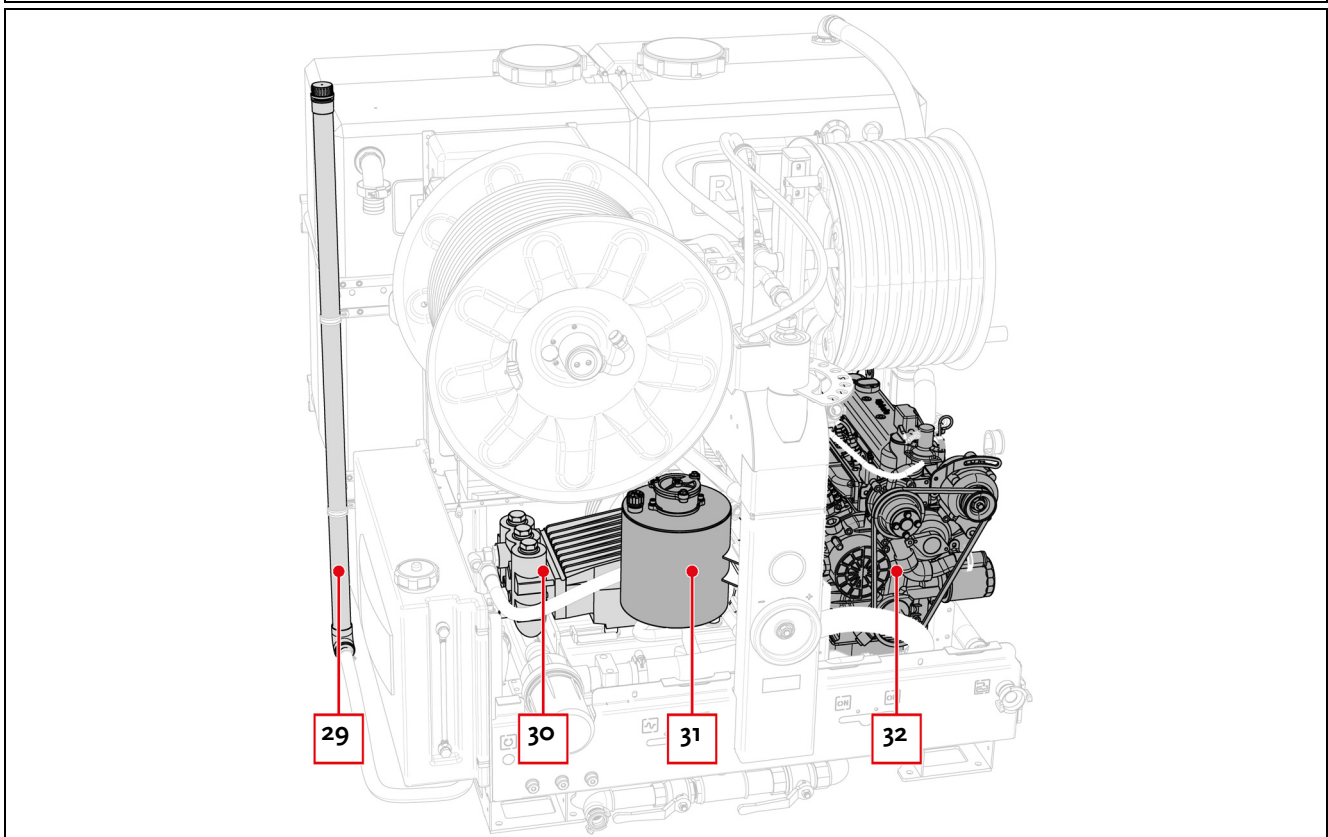
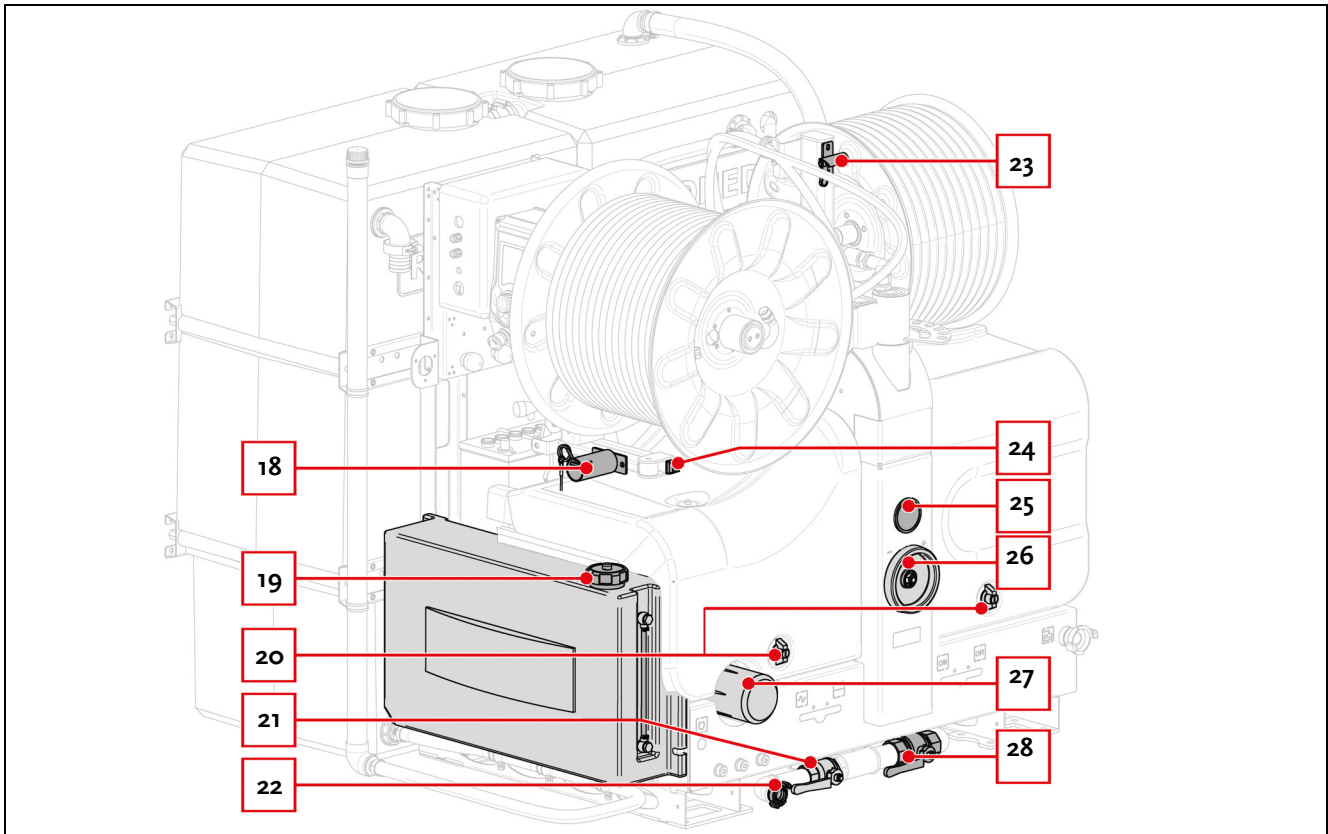

The following is a brief explanation of parts from the illustrations above that are not discussed further in the manual.

**Securing end of filling hose (3)**

The end of the filling hose is attached to this connection.

**Pump cover (4)**

Removing this cover will make the pump, battery and oil tank accessible for maintenance and service.

**Engine cover (5)**

Removing this cover will make the engine accessible for maintenance and service.

**12V connection (7)**

The 12 volt connection is used to connect accessories, such as a work light.

**Spray nozzles on holders (8)**

Screw the spray nozzles onto the nozzle holders.

**Battery (9)**

The battery supplies the machine with power.

**Supply valve, filling reel (11)**

Open this valve when the water tanks are filled through the filling hose.

**High pressure valve (14)**

This valve regulates the supply of water to the high pressure hose. If the Riomote control (option) is installed, the high pressure valve is always open. The water supply is then controlled by the valve on the actuator. The high pressure valve acts as a safety valve in an emergency: this allows you to immediately interrupt the supply of water to the high pressure hose.

**Locks, covers (20)**

The pump and engine cover are held in place with these locks.

**Connection, drain hose (22)**

Connect the drain hose here and place the end of the hose outside the vehicle when you want to empty the water tanks. Then the vehicle will remain dry inside.

**Reel latch (23)**

This latch prevents the reel from turning. It is operated by twisting the wings.

**Latch, swivel arm (24)**

The latch of the swivel arm holds the swivel arm in place. There are four different positions:

- > In the first position, the swivel arm is completely in the machine. This position is intended for driving the vehicle. In the other positions the vehicle must NOT be driven.

- > The other three positions are intended for positioning the high pressure hose as close as possible to the correct working direction. This ensures that the high pressure hose rolls off the reel smoothly.

It is operated as follows:

1. Press the button on the swivel arm latch:  
Swivel arm latch releases.
2. Swing the swivel arm to the desired position.
3. Release the button on the swivel arm latch: Swivel arm latch latches into the next hole it reaches.

### **Indicator, water level (29)**

This indicates the water level in the water tank.

## 2.2.2 Symbols on pressure gauge, pressure regulator and valve controls

### Pressure gauge (25)

The maximum operating pressure is indicated on a sticker near the pressure gauge.

Reduce the operating pressure with the handwheel of the pressure regulator until the indicator of the pressure gauge is halfway between 0 and the maximum operating pressure.



### Pressure regulator (26)

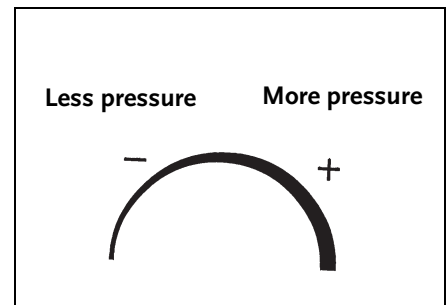

### Operation of high pressure valve (14)

Move the lever up to open the high pressure valve. Move the lever down to close the high pressure valve.

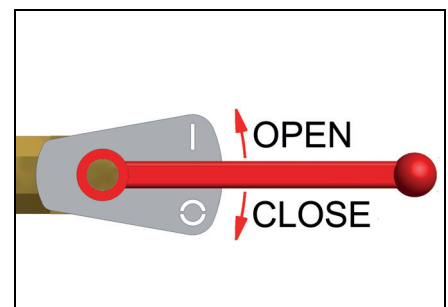

## 2.2.3 Accessories

The following are included as standard with the machine:

- Two nozzles for unblocking sewers: 'Open nozzle' and 'Blind nozzle', which are fitted on the end of the high pressure hose.
- One spray gun with lance for cleaning façades, terraces and floors. The spray gun is attached to the end of the high pressure hose using the open-end spanners. These open-end spanners are also supplied as standard.

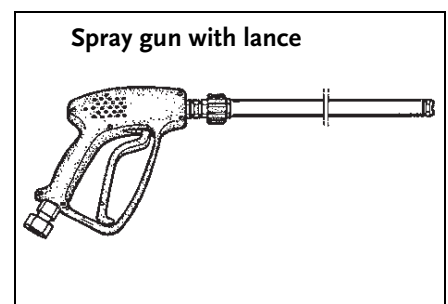
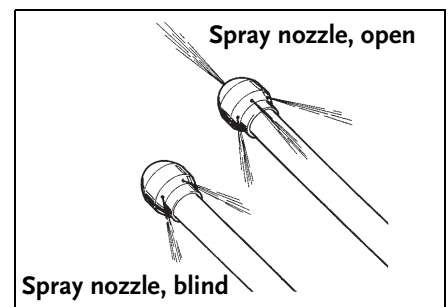

3. Two open-end spanners for tightening and loosening the spray gun.
4. This user manual
5. Engine documentation
6. One suction hose with strainer.
7. Attachment: high pressure pump
8. Attachment: exploded view drawings and diagrams.

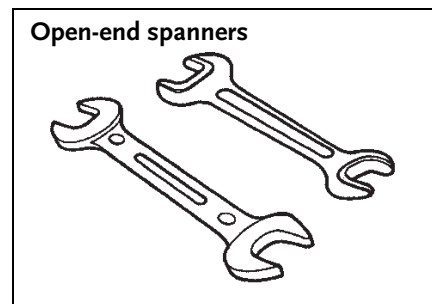

## 2.3 eControl+

### 2.3.1 Design and principle of operation

With the eControl+ you can operate the machine via the navigation knob. You can also use the eControl+ to control a number of options. The status is always shown on the display of the eControl+.



## 2.3.2 eControl+

- |                             |   |
|-----------------------------|---|
| 36. Lightbar                | 46. High pressure LED   |
| 37. Navigation bullets      | 47. High pressure on/off button   |
| 38. Function icons          | 48. Not applicable  |
| 39. Tachometer              | 49. Not applicable  |
| 40. Tachometer pointer      | 50. Navigation knob   |
| 41. Iconeco mode            | 51. Button, emergency stop  |
| 42. Pulsator icon           | 52. Key (3 positions: eControl+ off, manual operation and Riomote control (option)) |
| 43. High pressure reel icon |   |
| 44. Motor LED               |   |
| 45. Engine on/off button    |   |

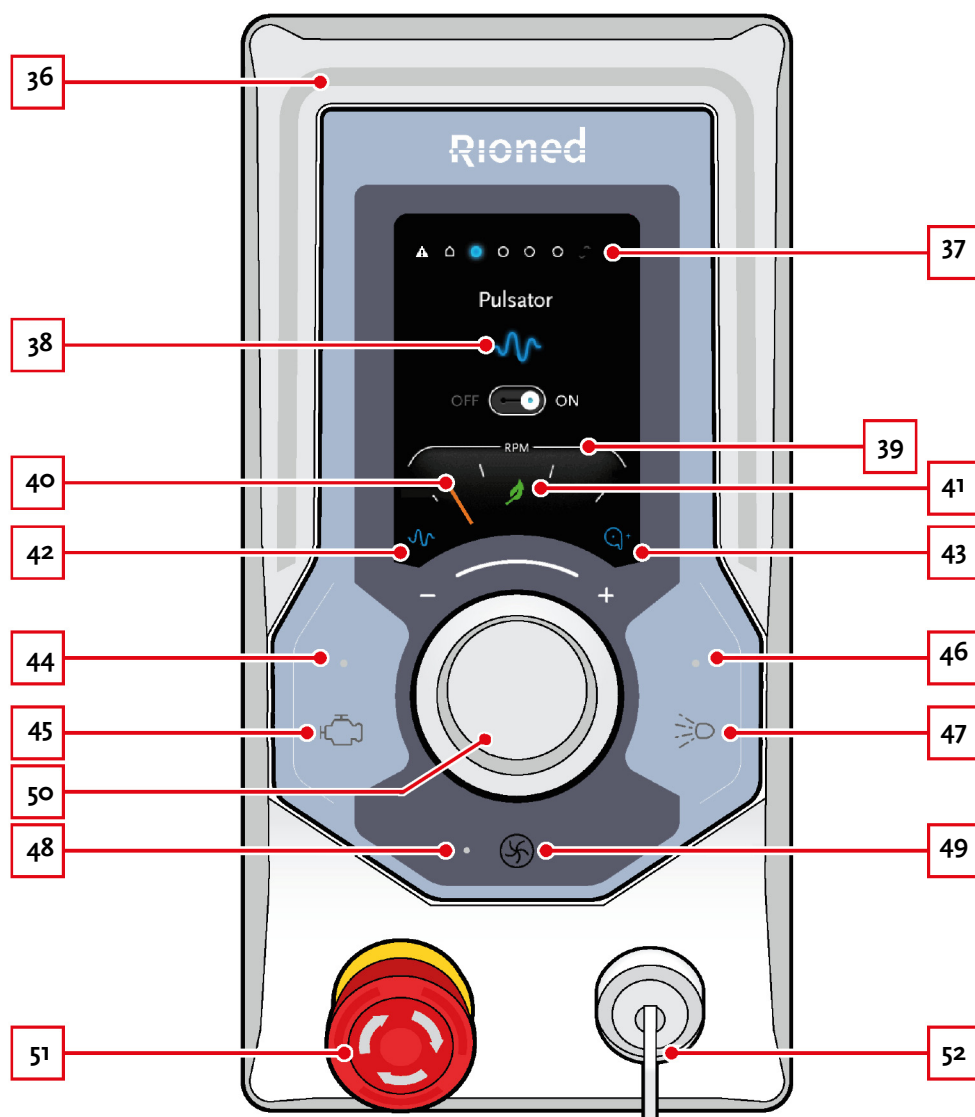

The following illustrations and text provide a more detailed description of the various parts of the eControl+.

### 2.3.3 Lightbar

The lightbar around the display is switched off (always grey) by default:

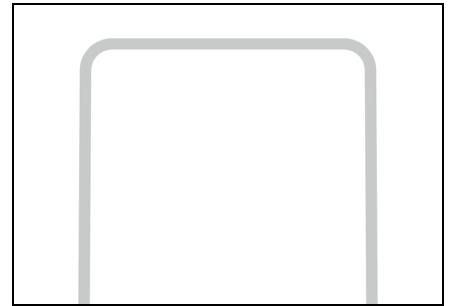

In the following cases it changes to one of these four colours:

#### BLUE



The Riomote control is set on the eControl+

#### RED



There is a fault

#### ORANGE



The diesel engine is being preheated or the high-pressure pump is running dry or the oil level is too low

#### GREEN



Spraying has been stopped by the ECO Start/Stop or the ECO Stop

### 2.3.4 Navigation bullets

The navigation bullets show how many menus are available. They are normally shown in one of two states:

The navigation bullets represent the following, from left to right:



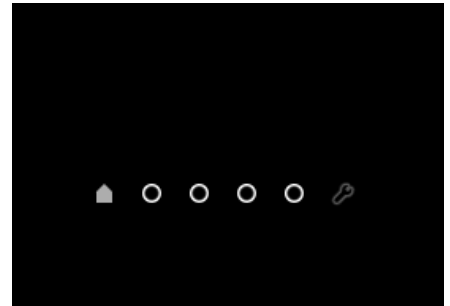



Inactive (grey):

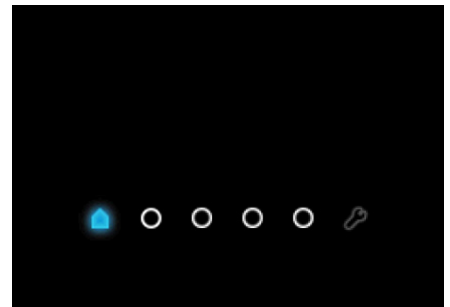

Active (blue):

Depending on where you are in the menu, one navigation bullet is visible or – in a pop-up – all navigation bullets disappear.



Fault	
Home	
Pulsator	
Reel	
Hose counter	
Eco mode	
Management	

### Fault

The first navigation bullet (Fault ) is only visible when a fault message is suppressed, for example 'too little water in the water tank (run dry)'. Only then can you navigate to this bullet. In other cases, the bullet is hidden.

Fault (inactive, grey):

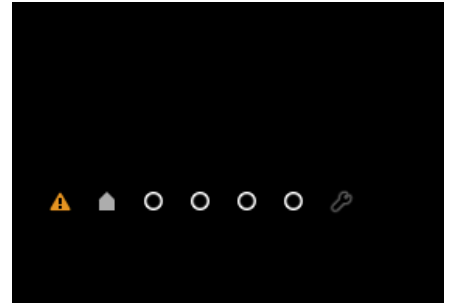

Fault (active, blue):

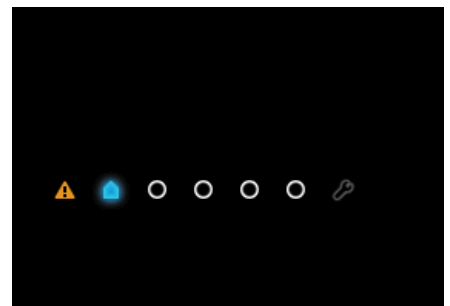

**Home**

The second navigation bullet (Home ) is always visible. You can always navigate to it.

**Pulsator, electric reel operation and hose counter**

The following three navigation bullets represent:

- > the pulsator
- > the reel
- > the hose counter

These bullets are only visible when the relevant function is available on the machine. For example, you can only see electric reel operation when this option is installed.

If a function is not available, the corresponding navigation bullet is not visible and you navigate to the next bullet.

**Eco mode**

If the engine has an eco mode and that mode is active, the engine will stop after some time if you stop spraying.

**Management**

The rightmost navigation bullet (Management ) is always visible, so you can always navigate to it.

### 2.3.5 Functions and symbols

A function (pulsator, electric reel operation or hose counter) may be shown in either of two ways: inactive and active. The pulsator is shown below, as an example:

Inactive (grey):

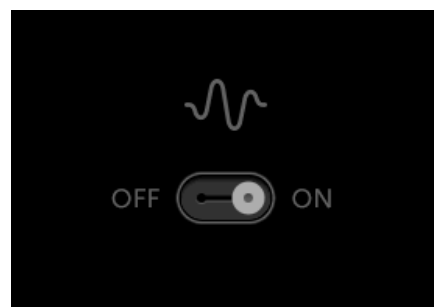

Active (blue):

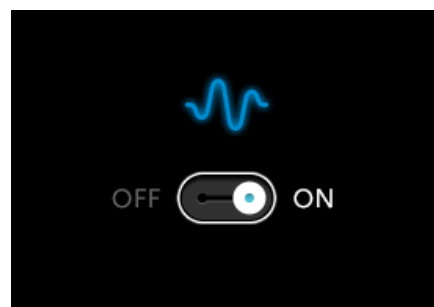

Depending on where you are in the menu, one function is visible or – in a pop-up – all navigation bullets disappear.

There are four different icons:

Pulsator switched on

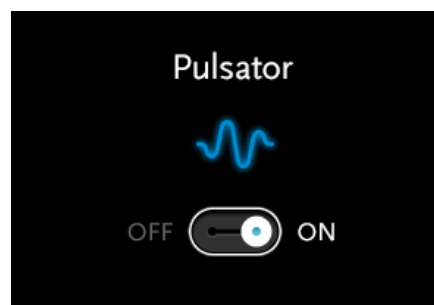

Reeling out switched on

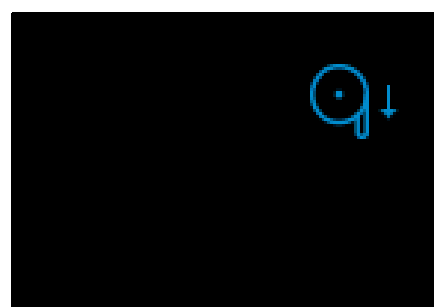

Reeling in switched on



Hose counter switched on

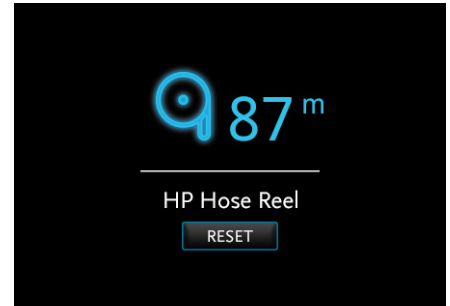

### 2.3.6 Tachometer

Just like on a car, the tachometer shows the engine speed, in revolutions per minute. The speed can be increased or decreased with the navigation button.

The tachometer can be displayed in the following four ways:

Inactive (standard)



Inactive (eco mode)



Active (standard)



Active (eco mode)





The tachometer status is always displayed. This status depends on where you are in the menu. The pointer indicates the current speed in revolutions per minute (1 line is 1000 rpm).

If the tachometer is inactive, the background is black. The background turns blue when the tachometer is active. If the machine has an eco mode and that mode is active, this is always shown by the eco

symbol  on the display. This symbol is shown in the tachometer.

The tachometer is accessible in two ways:

- > In any menu, briefly press the engine on/off button  to return to the tachometer.
- > Go to the Home  navigation bullet. The speed can now be controlled.

## 2.4 Riomote control (option)

### 2.4.1 Introduction

The Riomote control can be purchased as an option for a machine with an eControl+.

With the Riomote control you can control the machine remotely. There are three different Riomote controls available:

1. 5-channel Riomote control
2. 7-channel Riomote control

3. 9-channel Riomote control

**NOTE**  
The buttons on your Riomote control may differ from those shown in this manual. See the symbols on your remote control for the actual functions. The functions of the buttons may also differ due to customer-specific preferences.

**2.4.2 Preparation for use**

The key switch of the eControl+ has three positions:

1. Insert key:

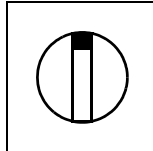

2. Position 1 (operation with eControl+):

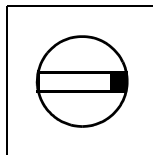

3. Position 2 (Riomote control):

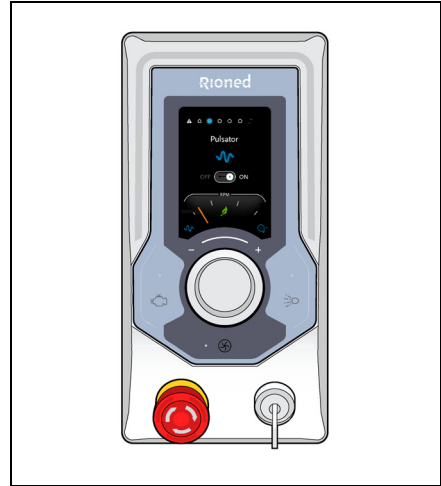
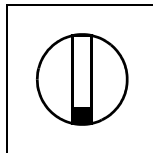

 **WARNING!**  
Before you use the Riomote control, make sure the emergency stop is working properly.



Do this as follows:

1. Insert the key into the key switch:
2. Turn the key half a turn clockwise to position 2.  
The text 'Work Safe' will now appear for two seconds:

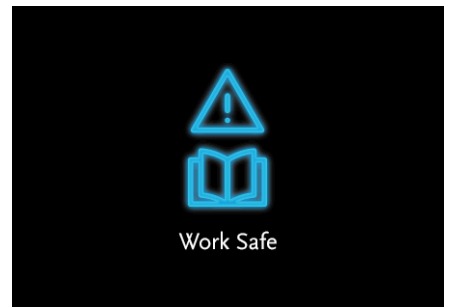

The text 'Riomote Control ON' is displayed continuously:

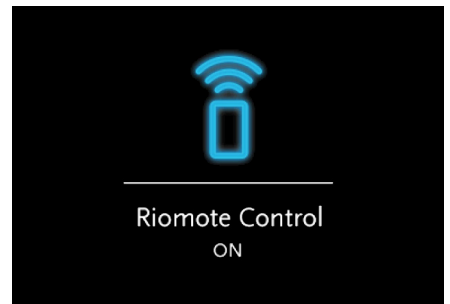

The lightbar flashes blue:

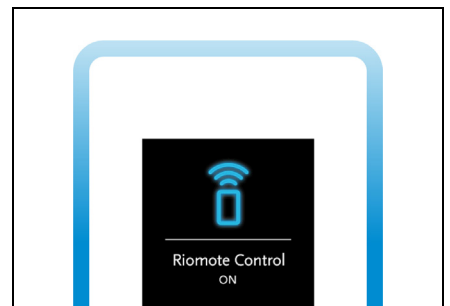

3. Now switch on the Riomote control with the START button at the bottom right:



- Continue to hold this button until the lightbar no longer flashes.  
The lightbar stays blue when the Riomote control is connected to the receiver.
- Press the 'Start engine' button on the Riomote control to start the engine.



### NOTE

The 9-channel Riomote control is shown as an example.

- Press the emergency stop button on the Riomote control:  
If everything is working properly, the engine will now be shut off.



### WARNING!

If the engine does NOT shut off when the emergency stop button is pressed, the machine may NOT be operated with the Riomote control. In that case, contact Rioned.

### 2.4.3 Replacing the battery

If the indicator light on the Riomote control lights up, the battery should be replaced with a charged battery:

If the battery is not replaced, the Riomote control will switch off after a short time.

Charge the flat battery so it can be used again. The battery charger is located in the vehicle cab.

Battery operating time: 12 hours (at 20 °C)

Battery charging time: 4 hours (between 5 and 45 °C)

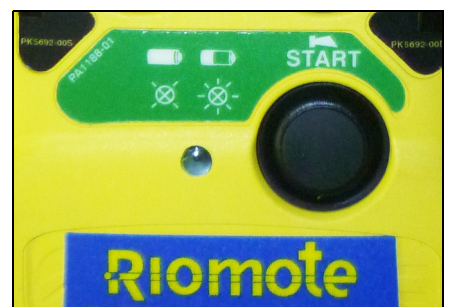

### 2.4.4 5-channel Riomote control

The 5-channel Riomote control has the following buttons:

1. Decrease speed
2. Increase speed
3. Stop spraying
4. Start spraying
5. Emergency stop

START Button at bottom right: Switch Riomote control on/off

After pressing the corresponding button, the following is displayed on the eControl screen:

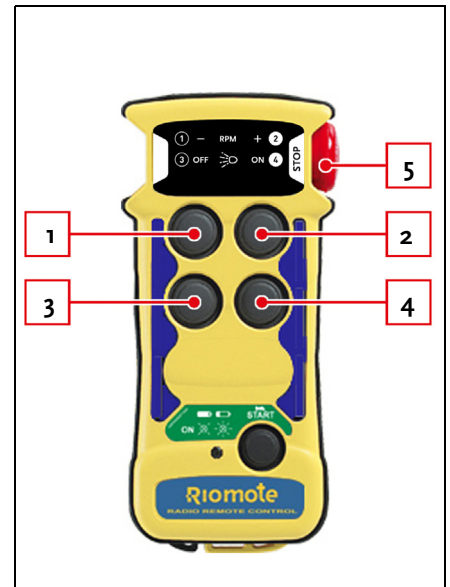

1. RPM - (decrease speed)
2. RPM+ (increase speed)

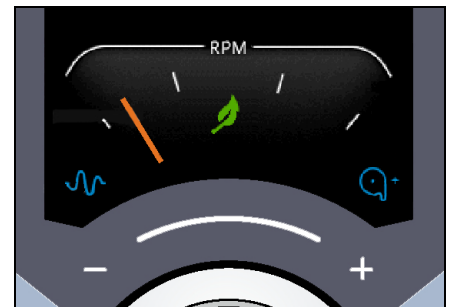

3. Stop spraying:

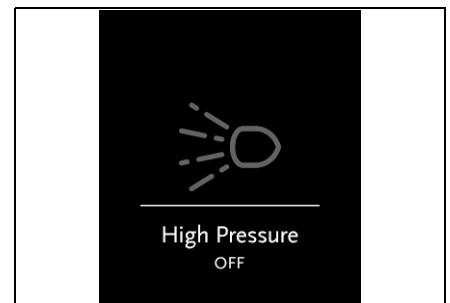

4. Start spraying:



### 2.4.5 7-channel Riomote control

The 7-channel Riomote control has the following buttons:

1. Decrease speed
2. Increase speed
3. Stop spraying
4. Start spraying
5. Stop engine
6. Start engine
7. Emergency stop

START Button at bottom right: Switch Riomote control on/off

After pressing the corresponding button, the following is displayed on the eControl screen:

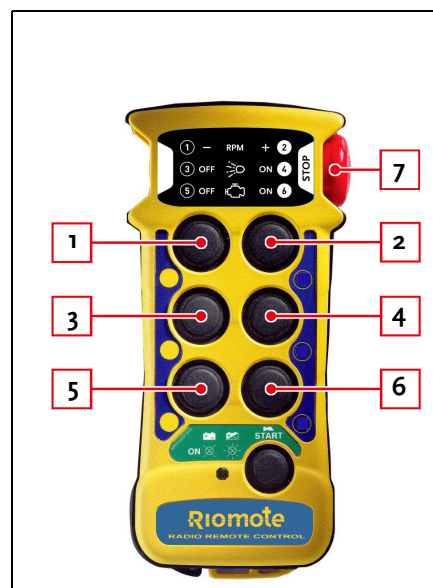

1. RPM - (decrease speed)
2. RPM+ (increase speed)

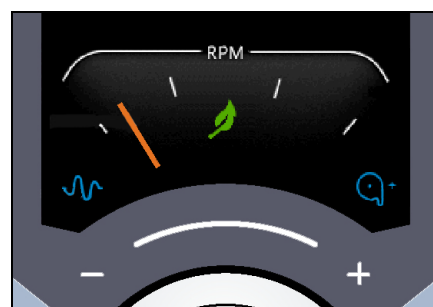

3. Stop spraying:

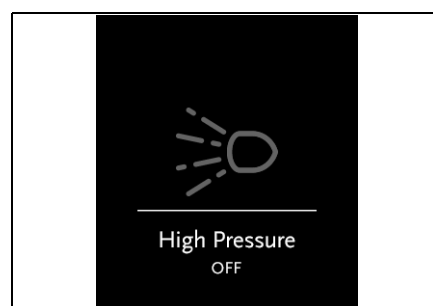

4. Start spraying:

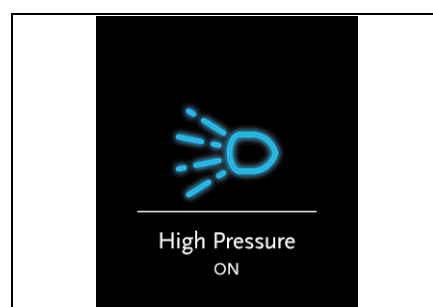

5. Stop engine:

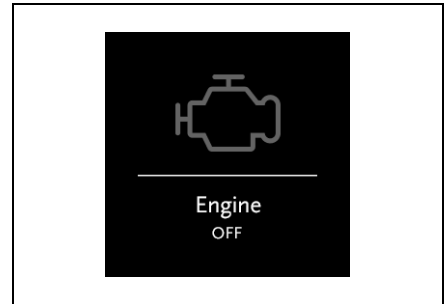

6. Start engine:

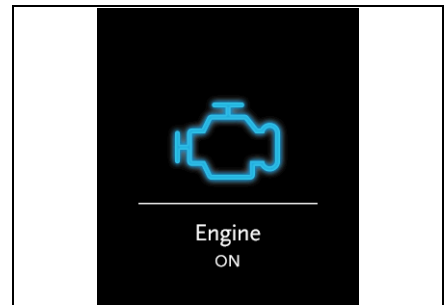

### 2.4.6 9-channel Riomote control

The 9-channel Riomote control has the following buttons:

1. Decrease speed
2. Increase speed
3. Stop spraying
4. Start spraying
5. Stop engine
6. Start engine
7. Reel in high pressure hose (rocker switch up)
8. Reel out high pressure hose (rocker switch down)
9. Emergency stop

START Button at bottom right: Switch Riomote control on/off

After pressing the corresponding button, the following is displayed on the eControl screen:

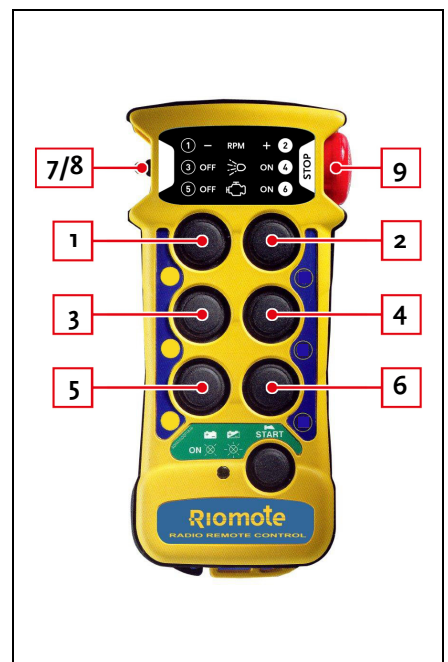

1. RPM - (decrease speed)
2. RPM+ (increase speed)

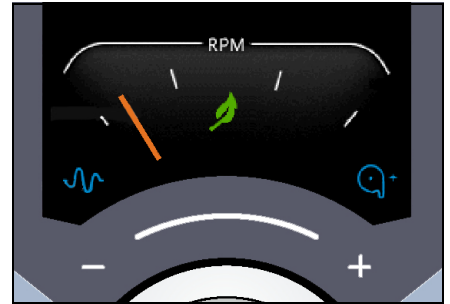

3. Stop spraying:

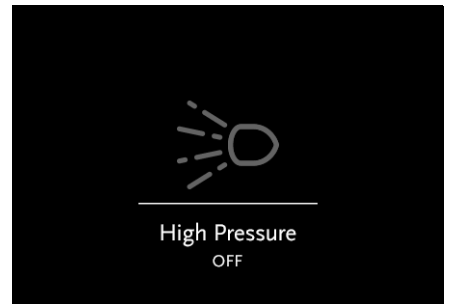

4. Start spraying:



5. Stop engine:

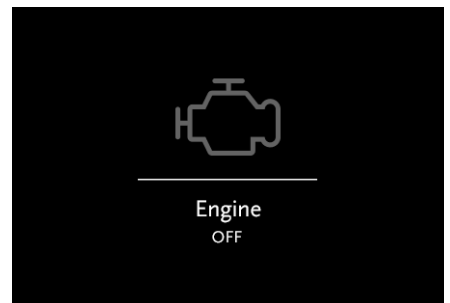

6. Start engine:

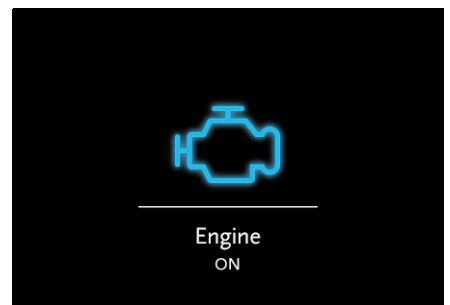

## 3 Safety

### 3.1 Introduction

This user manual contains very important safety instructions. In this chapter we provide general instructions. ALWAYS follow these instructions for use and maintenance. In other chapters we provide specific safety instructions for each action or situation. ALWAYS follow these instructions too.

Also observe the following safety instructions:

- > internal work, operating and safety instructions
- > national accident prevention regulations

### 3.2 General danger symbol

In this user manual we provide various safety instructions. If these instructions are not followed, there is a danger to persons. Such a safety instruction is indicated by this general danger symbol (in accordance with DIN 4844-W9):



### 3.3 Working safely

ALWAYS take these three important points into account when working and maintaining the machine:

- > You must NEVER remove protection from moving parts while the machine is in operation.
- > You must dispose of leaked hazardous substances in such a way that there is no danger to yourself, your colleagues or the environment. Observe the environmental regulations.
- > Prevent all electrical hazards.

### 3.4 Dangers of non-compliance with safety instructions

Possible consequences of non-compliance with safety regulations:

#### **Dangers to persons**

This concerns the exposure of persons to electrical, mechanical or chemical hazards.

#### **Dangers to environment**

This includes, for example, the danger to the environment due to leakage of hazardous substances.

#### **Dangers to the machine**

This concerns:

- > failure of important functions of the machine
- > failure of prescribed maintenance and repair methods

#### **NOTE**

Failure to comply with the instructions may result in the loss of any right to compensation.

### 3.5 Use only by authorized personnel

Your employer must carefully document the following:

- > the level of responsibility
- > the authorizations of the personnel
- > the supervision of personnel

You may ONLY operate, service and inspect the machine if you are authorized by your employer and have the necessary qualifications. Rioned can provide training if necessary.

You must have read and understood these operating instructions completely before you start working with the machine. You must keep the manual with the machine.

### 3.6 Bystanders

- > ALWAYS consider your responsibility to other people when working with this machine.
- > Keep unauthorized persons, especially children or animals, out of range of the machine.

### 3.7 Restrictions on use

The machine may ONLY be used for:

- > unblocking sewers
- > for cleaning façades, terraces and floors

NEVER suck up the following substances (option suction venturi):

- > combustible liquids
- > chemical substances
- > substances subject to special rules

Do NOT use the machine in an explosive environment.

Rioned ONLY guarantees the safety when working with the machine if the machine is used as described in this user manual.

NEVER exceed the following limit values (EN IEC 60204-1):

- > ambient temperature: +5 to +40 °C
- > storage temperature: -25 to +55 °C
- > humidity: 50% at +40 °C (higher at lower temperatures, e.g. 90% at +20 °C)
- > elevation of operation: the machine works up to a maximum elevation of 1000 m without any problems. Above this elevation the machine may not function as well due to the lower air pressure.

If the machine is not functioning or displays faults, DO NOT continue working. In that case, contact Rioned by phone (tel. no. +31 13-5479100).

### 3.8 Thunderstorm

We ADVISE AGAINST working with the machine when the weather conditions or forecasts are unfavourable. Consider thunder and lightning in particular!

### 3.9 Spraying

ALWAYS follow the instructions below when spraying:

- > NEVER point the jet at people or animals.
- > If skin penetration occurs, consult a DOCTOR immediately.
- > NEVER spray on live parts, such as electrical equipment.
- > NEVER spray the machine itself.
- > Prevent damage from splashing or flying parts.



This safety sticker shows you what you should not spray on:  
 Recommendation: do not use spray lances shorter than 75 cm.

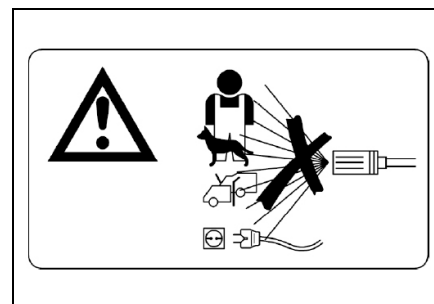

### 3.10 Spray break

If you leave the spraying area for a short time, do the following:

1. Stop the machine (see section 'Stopping spraying' in 'Unblocking a sewer' and section 'Stopping spraying' in 'Cleaning a wall, terrace or floor').
2. Depressurize the high pressure hose. Do this as follows:
  - Open the high pressure valve.
  - Squeeze the trigger of the spray gun.

### 3.11 Sewer gases

If you use the machine for sewer cleaning, you may be exposed to bacteria and sewer gases.  
 This is your own responsibility.

### 3.12 Water tank

- > It is PROHIBITED to drive with a full water tank if the load capacity is exceeded!
- > Fill the water tank with water ONLY.

### 3.13 Emergency stop

The machine is equipped with an emergency stop in the form of a button.

Follow the instructions below:

- > Ensure that the emergency stop is ALWAYS easily accessible.
- > Use the emergency stop ONLY in the event of a dangerous situation or one that is likely to become dangerous.
- > Press the button. The machine stops immediately.
- > DO NOT use the emergency stop to stop the machine under normal operating conditions.

After use of the emergency stop:

1. First make sure that the danger is no longer present.
2. Unlock the emergency stop (turn the button to the left or right).

You can now continue working.

### 3.14 Levers and valves

- > NEVER fasten the levers in position in any way whatsoever, unless otherwise instructed.

### 3.15 Personal protective equipment

ALWAYS use the following personal protective equipment when working with the machine:

- > hearing protection
- > safety glasses or face shield
- > waterproof work gloves

- > waterproof workwear
- > helmet
- > spray boots with steel toes

### 3.16 Water discharge

Ensure that the water is drained off properly.

Clean the discharge water before discharging it into the sewer system in the following two cases:

- > when cleaning with harmful chemicals, or
- > when the object to be cleaned is contaminated with environmentally harmful substances.

### 3.17 Other machine safety provisions

#### 3.17.1 Introduction

In addition to the emergency stop, the machine has the following safety provisions. The numbers after the provisions and their location can be found in the section '*Design and principle of operation*'.

#### 3.17.2 Pressure regulator

The pressure regulator ensures that the operating pressure never becomes too high and thus acts as a safety valve.

#### 3.17.3 Protective covers

Your machine is fitted with various protective covers and panels. It is forbidden to remove these protective covers unless maintenance is to be carried out on the machine. You should then stop the machine and let it cool down if necessary.

Protective covers and lockable panels must be locked when the machine is in use.

The locks may only be opened during maintenance and servicing by authorized personnel.

### 3.18 Safety sticker

The safety sticker is located on the back of the vehicle. The symbols used have the following meaning:

1. Hearing, head and eye protection must be worn
2. Safety shoes with extra protection required
3. Reading the manual is mandatory
4. Safety gloves with wrist protection required
5. Protective workwear required
6. Not potable water
7. Risk of slipping
8. Beware of hand injury
9. Rotating machine
10. Warning for automatically starting machine





## 4 Operation: standard functions

### 4.1 Introduction

In this chapter we first describe the checks you must carry out before departure and the preparations required at the workplace. Then the different ways to start the engine are explained.

Next the work will be discussed: unblocking a sewer, properly handling the high pressure hose and cleaning a wall, terrace or floor.

### 4.2 Checks before departure

ALWAYS check the following before you drive off with your vehicle:

- > Is the high pressure hose completely rolled up?
- > Is the high pressure reel secured in the hose holder?
- > Is the high pressure hose secured in the hose holder with the safety clip?
- > Is the filling hose completely rolled up?
- > Is the end of the filling hose secured to the frame?
- > Is the filling reel fixed by means of the reel latch?
- > Is the swivel arm fully retracted and secured?
- > Is the hose guide secured?

Check fluids:

- > Check the oil level of the engine with the dipstick.
- > Top up as required.
- > Check that there is enough fuel in the fuel tank.
- > Top up the tank if necessary.

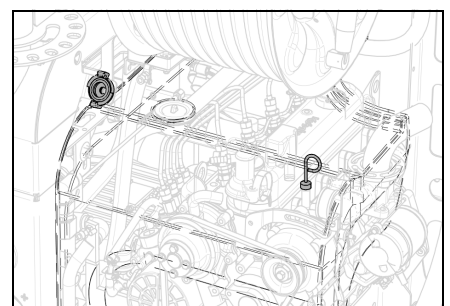
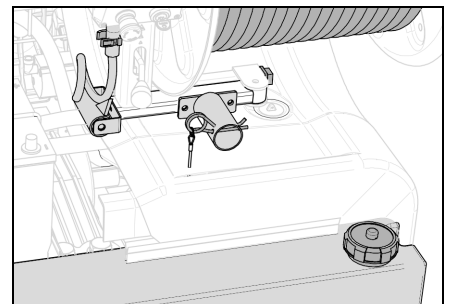
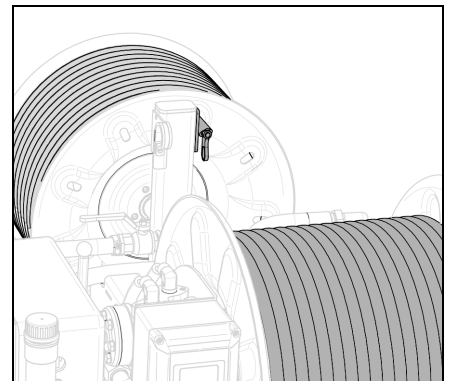

## 4.3 Preparations at the workplace

### 4.3.1 Preparing the vehicle

1. Park the vehicle at the desired location and engage the parking brake.
2. When used on a slope, block the wheels of your vehicle with wheel chocks.
3. Mark the work area in accordance with local regulations.



### 4.3.2 Before starting

- > Check the oil level of the high pressure pump, hydraulic system oil tank and engine.
- > Top up as required.

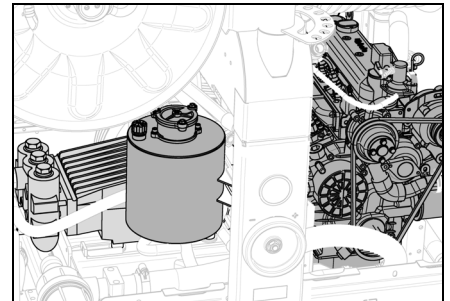

- > Check that the water filter is clean.
- > Clean the filter if necessary.
- > Check that the high pressure valve is closed.
- > Check that the supply valve to the water filter is open.
- > Check that the drain valve is closed.
- > Check that there is enough fuel in the fuel tank. Top up as required.

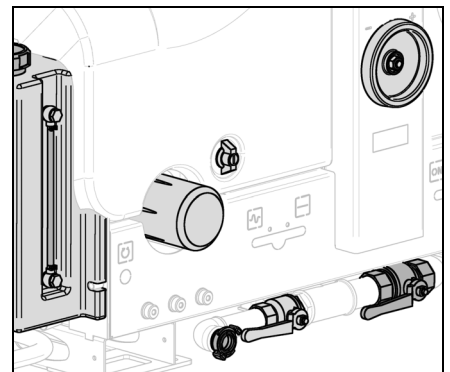

#### NOTE

It may be that fuel from the vehicle is used. You may use it up before you realize it, in which case the work must stop. Then it is also no longer possible to drive the vehicle. Make sure you have a jerrycan with fuel.

The water tank can be filled in four ways:

#### Via the filling line:

1. Connect a filling hose to the coupling of the filling line.
2. Open the filling valve.
3. Open the water tap.

#### Via the filling hose

Connect the filling hose to a tap, open the filling valve and open the water tap

#### Through the fill opening on the water tank

Through the fill opening, the water tank can be manually filled with water

#### Through the suction venturi (option)

See chapter '*Operation of additional functions*', section '*suction venturi*' for more information.

The maximum water temperature is 60 °C.

- > Turn the pressure regulator knob anticlockwise.
- > Screw the required attachment onto the high pressure hose:

For unblocking a sewer: the spray nozzle.

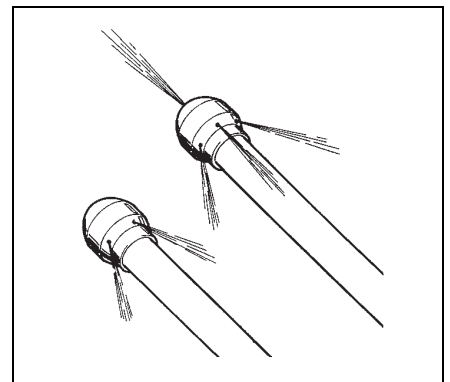
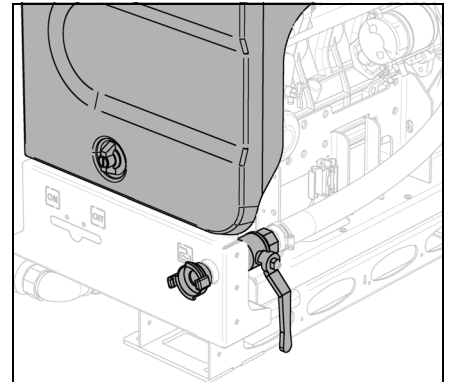

For cleaning façades, terraces and floors: the spray gun.

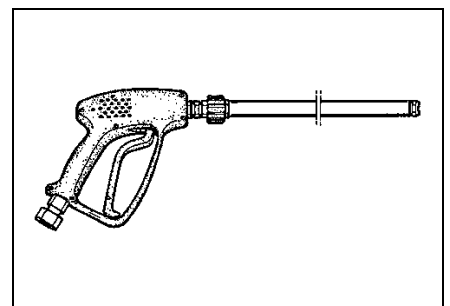

### 4.3.3 Workstations

The machine has four different workstations. These workstations are:

#### Behind the machine at the eControl+

The following operation is possible here:

- > operation with eControl+
- > emergency stop with eControl+

**At the manhole or sewer pipe**

The following operation is possible here:

- > operation with eControl+ at a distance of less than one metre
- > operation with Riomote control

Risk at this workstation: the emergency stop can only be operated with the Riomote control at a distance of less than two metres.

**At the spray site**

Here you work with the spray gun with lance.

**Remotely with Riomote control**

Here you carry out work closer to the blockage. The maximum distance to the machine is up to 90% of the total length of the high pressure hose.

Risk at this workstation: no supervision of the machine during one-man operation.

**4.4 Starting the engine**



**ALWAYS wear personal protective equipment! See section 'Personal protective equipment' for all the protective equipment.**



**4.4.1 Starting the engine with the eControl+**

Start the vehicle engine with the eControl+ in the following way:

1. Insert the key into the key switch.
  
2. Turn the key a quarter turn clockwise to position 1.  
The text 'Work Safe' will now appear for two seconds:



The text 'Manual Control ON' is displayed for two seconds:

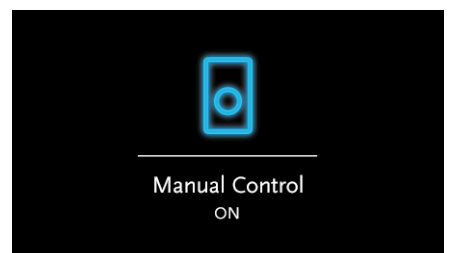



Then the home screen is shown:

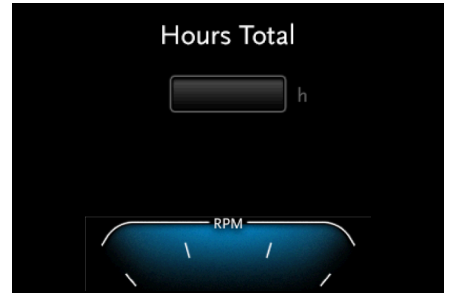

3. If the 'ECO Start/Stop' or 'ECO Stop' option is available, the eco mode is activated by default (see section 'Eco mode eControl+').  
Check to see if a fault icon is displayed:
  - If there is a fault icon: see section 'Navigation bullets'.
  - No fault icon: continue with the next step.



4. Press and hold the Engine on/off  button.  
The engine is now started.  
When the engine is running, the engine LED is blue:

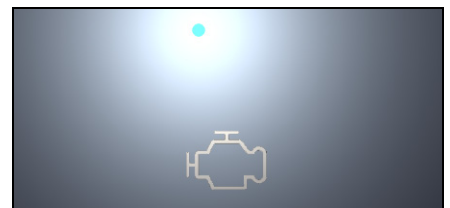

The text 'Engine ON' is displayed for two seconds:

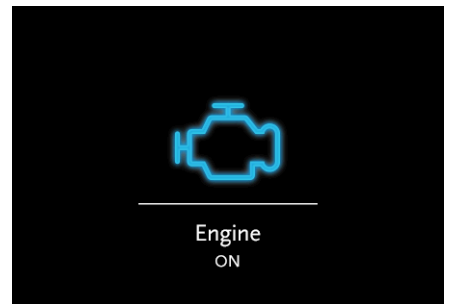

5. Let the engine warm up. After three minutes of warming up, the machine is ready for use.  
Then the home screen is shown:

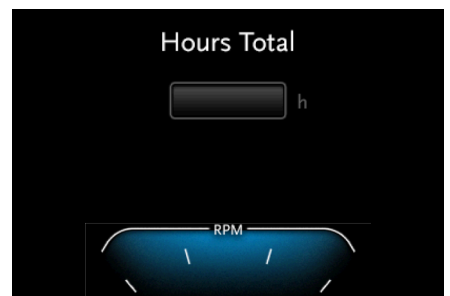

6. With the navigation knob you can now do the following:
  - Turn the navigation knob to increase (clockwise) or decrease (anticlockwise) the speed:
  - Press the navigation knob to go to the navigation bullets:

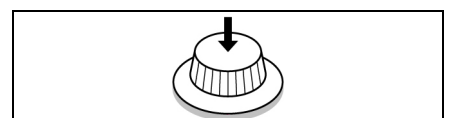
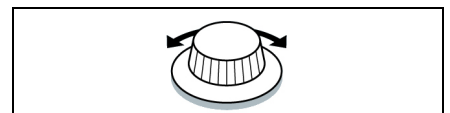

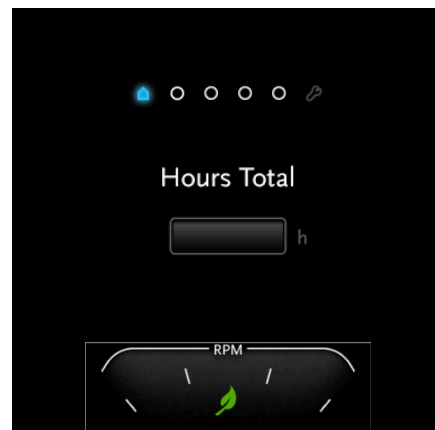

### 4.4.2 Starting the engine with the Riomote control

Start the vehicle engine with the Riomote control in the following way:

1. Insert the key into the key switch:
  
  
  
  
  
  
  
  
  
  
2. Turn the key half a turn clockwise to position 2.  
The text 'Work Safe' will now appear for two seconds:

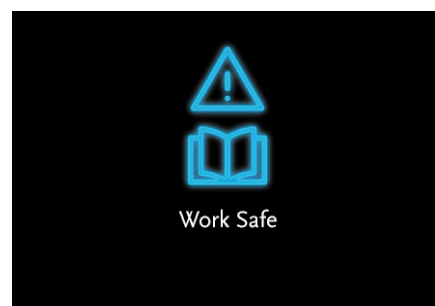
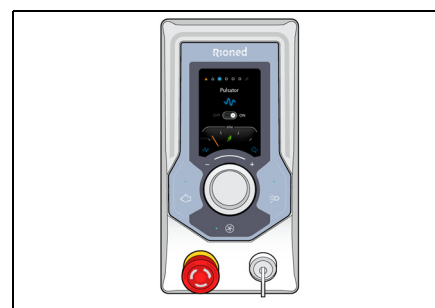

The text 'Riomote Control ON' is displayed continuously:

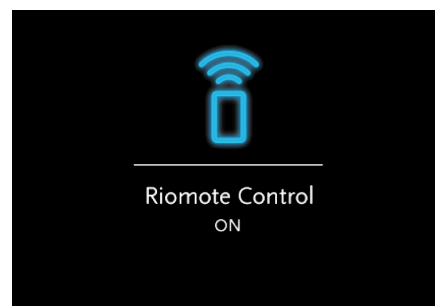

The Lightbar flashes blue:

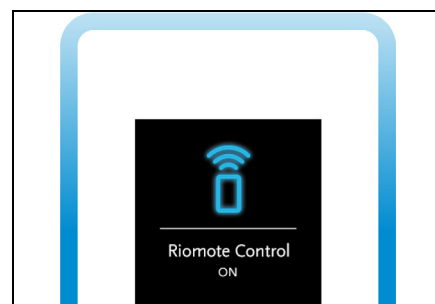

- Now switch on the Riomote control.  
The Lightbar stops flashing and stays blue when the Riomote control is connected to the receiver.  
Check to see if a fault icon is displayed:
  - If there is a fault icon: see section '*Navigation bullets*'.
  - No fault icon: continue with the next step.



- For safety reasons, remove the key from the eControl+:

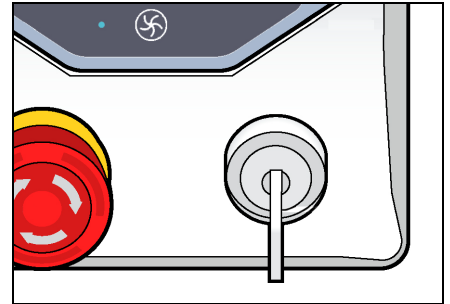

- Press button 6 'Start motor' (9-channel) or button 2 'Start' (11-channel) on the Riomote control.  
The engine is now started.  
When the engine is running, the engine LED is blue:

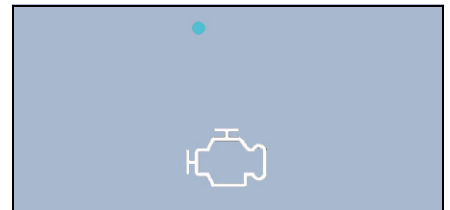

- Increase the speed by pressing button 2 'Increase speed' (9-channel) or button 6 'Throttle up' (11-channel).
- Let the engine warm up. After three minutes of warming up, the machine is ready for use.

### 4.4.3 Unblocking a sewer

### 4.4.4 Spray nozzle warning

**WARNING!**  
Ensure that the spray nozzle never exits the sewer while spraying. A high pressure water jet can cause serious injuries!

How do you prevent this?

A mark has been applied approximately five meters from the end of the hose. When you see this mark, do the following:

- Turn off the high pressure.
- Then pull the hose completely out of the pipe.

### 4.4.5 Preparations for spraying

The machine has two spray nozzles for unblocking sewers: 'Open nozzle' and 'Blind nozzle'.

- Attach the spray nozzle to the end of the high pressure hose as follows:
  - first fit the O-ring to the threads of the high pressure hose

- screw the 'Open nozzle' onto the high pressure hose
- 2. Reel out the high pressure hose in one of the following ways:
  - with the hydraulic hose reel (see section '*Hydraulically reeling high pressure hose or suction hose in/out*')
  - with the eControl+ (see section '*Reeling high pressure hose in/out with eControl+*')
  - manually (see section '*Manually reeling high pressure hose or suction hose in/out*')
  - with the Riomote control (see section '*Reeling in/out with the Riomote control*')
- 3. Place the spray nozzle in the pipe to be cleaned.
- 4. Open the high pressure valve at the high pressure reel manually.
- 5. Turn the pressure regulator knob completely open (clockwise).
- 6. Start the engine if it has not yet been started.

#### 4.4.6 Starting spraying



**TAKE CARE!**

Only switch on the high pressure at idling speed!

Spraying can be started in two ways: with the eControl+ and with the Riomote control.

##### Starting spraying with the eControl+

1. Press the High pressure on/off  button.  
The water now sprays out of the nozzle at the end of the hose.  
The LED for high pressure lights up blue:



The text 'High Pressure ON' is displayed for two seconds:

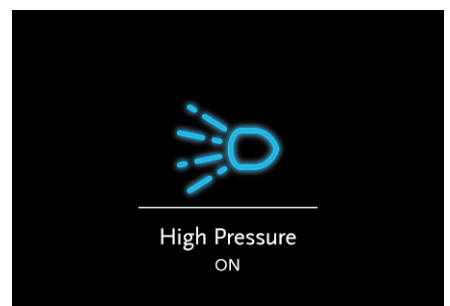

After five seconds, the home screen is displayed:

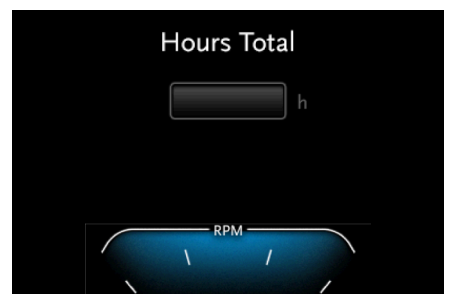

- Turn the navigation knob to increase (clockwise) or decrease (anticlockwise) the speed:

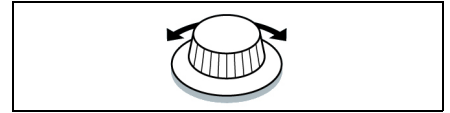

### Starting spraying with the Riomote control

- Press button 4 'Start spraying' (9-channel) or button 4 'HP on' (11-channel).
- Press button 2 'Increase speed' (9-channel) or button 6 'Throttle up' (11-channel).

The hose will now unwind and at the same time work its way into the clogged sewer:

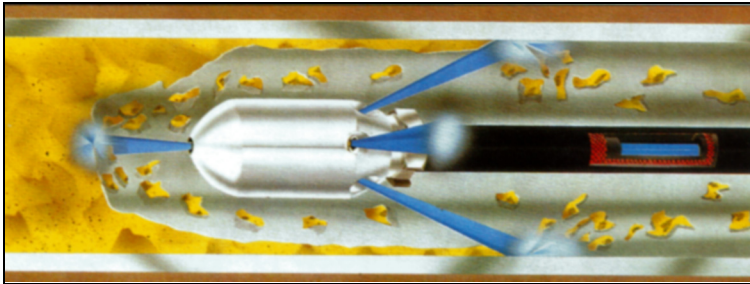

- Check whether the water is drained off.
- Continue flushing for a while after the blockage is removed.
- Reel the hose in slowly at the same time.

### 4.4.7 Stopping spraying

After unblocking, it is important to flush as follows: replace the 'Open nozzle' with the 'Blind nozzle'.



#### TAKE CARE!

- Reel the high pressure hose onto the reel under pressure. If you do not do this, the reel can be damaged by the squeezing action.
- Has the machine run out of water?
  - First reel the high pressure hose out.
  - Only then apply pressure to it.

Spraying can be stopped in two ways: with the eControl+ and with the Riomote control.

#### Stopping spraying with the eControl+

- > Press the High pressure on/off  button.
- > The LED for high pressure goes out:

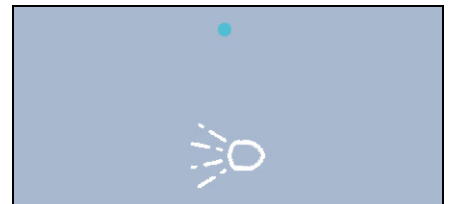

- > The text 'High Pressure OFF' is displayed for two seconds:
- > No more water comes out of the nozzle.
- > The engine speed decreases.

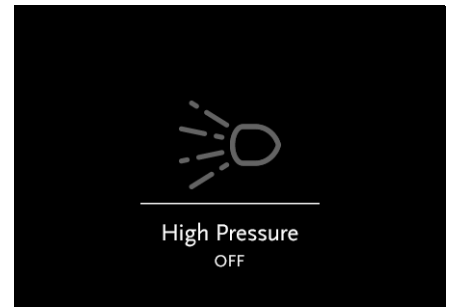

### Stopping spraying with the Riomote control

- > Press button 3 'Stop spraying' (9-channel) or button 3 'HP off' (11-channel) on the Riomote control.
- > The LED for high pressure on the eControl+ goes out.
- > No more water comes out of the nozzle.
- > The engine speed decreases.

### 4.4.8 Handling the high pressure hose

Handling the high pressure hose carefully:

- > Make sure there are no sharp objects near the hose.
- > Make sure no vehicles drive over the hose.
- > Clean the hose after each use.
- > Use only the special repair couplings if the hose requires repair.

## 4.5 Cleaning a wall, terrace or floor

### 4.5.1 Warnings for spray gun



#### **WARNING!**

**ALWAYS** observe the following warnings when working with the spray gun:

**Before use:**

- Set the pressure regulator to half of the maximum operating pressure (see section 'Symbols on pressure gauge, pressure regulator and valve controls').
- Then start the machine.

**After starting and while working:**

- The operating pressure can be increased to the desired pressure. Do this by turning knob on the pressure regulator.
- **NEVER** exceed the specified maximum operating pressure! (See section 'Symbols on pressure gauge, pressure regulator and valve controls'.)

See also the safety instructions for the spray site in the Introduction.

### 4.5.2 Preparations for spraying

1. Attach the spray gun to the end of the high pressure hose as follows:
  - First fit the O-ring to the threads of the high pressure hose.

- Then screw the spray gun onto the high pressure hose using the supplied spanners.
2. Unreel the high pressure hose ALL THE WAY.
  3. Open the high pressure valve at the high pressure reel.
  4. Start the engine if it has not yet been started.

### 4.5.3 Pressurizing the system

Pressurizing can be started in two ways: with the eControl+ and with the Riomote control.

#### Pressurizing with the eControl+

1. Press the High pressure on/off  button.
2. Turn the navigation knob to increase (clockwise) or decrease (anticlockwise) the speed:

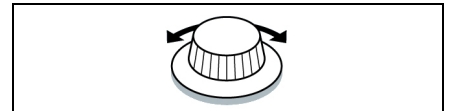

#### Pressurizing with the Riomote control

1. Press button 4 'Start spraying' (9-channel) or button 4 'HP on' (11-channel) to start spraying.
2. Press button 2 'Increase speed' (9-channel) or button 6 'Throttle up' (11-channel) to increase the speed, or button 1 'Reduce speed' (9-channel) or button 5 'Throttle down' (11-channel) to reduce the speed.

### 4.5.4 Starting spraying



#### Starting spraying with the spray gun

1. Turn the pressure regulator knob clockwise until the desired pressure is reached.  
The set pressure can be read on the pressure gauge when the gun is spraying.
2. Squeeze the trigger of the spray gun to start spraying.  
Release the trigger to stop spraying.

### 4.5.5 Depressurizing the system

The system can be depressurized in two ways: with the eControl+ and with the Riomote control.

#### Depressurizing the system with the eControl+

1. Turn the navigation knob anticlockwise to reduce the speed:  
Reduce the speed by turning the navigation knob on the eControl anticlockwise:
2. Press the High pressure on/off  button.  
Pressure drops off.
3. Press and hold the Engine on/off  button for at least one second.

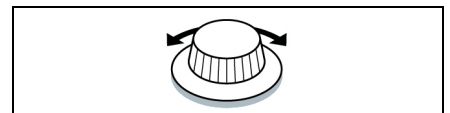

### Depressurizing the system with the Riomote control

1. Press button 1 'Reduce speed' (9-channel) or button 5 'Throttle down' (11-channel) to reduce the speed.
2. Press button 3 'Stop spraying' (9-channel) or button 3 'HP off' (11-channel) to depressurize the system.
3. Press button 5 'Stop engine' (9-channel) or button 2 'STOP' (11-channel) to stop the engine.

## 4.6 Ending the work

### 4.6.1 Cleaning up, securing and draining

At the end of the work, complete the following steps:

- > Clean up the high pressure reel:
  - a. Close the high pressure valve.
  - b. Roll up the high pressure hose.
  - c. Secure the high pressure hose in the hose holder.
  - d. Secure the high pressure hose reel (position 'O').
  - e. Secure the hose guide.
- > Put away all the attachments.
- > Put away the Riomote control.
- > Close the transfer valve.
- > Drain any water that is still in the water tank via the drain valve.





#### **WARNING!**

**Drain water tanks, water filter, water pipes, water hoses and water containers after EVERY service to prevent contamination with Legionella bacteria!**

### 4.6.2 Additional steps during freezing temperatures

The high pressure section of the machine is at high risk of freezing during freezing temperatures. Therefore ALWAYS take the following precautions before departure after you have finished your work:

1. Open the drain valve for the water filter. This will drain the water tank.
2. When no more water comes out of the valve, Close the drain valve.
3. Unscrew the cap of the water filter.
4. Let the remaining water flow out.
5. Screw the cap of the water filter tight again.
6. Fill the water tank with 25 l antifreeze.
7. Turn the pressure regulator knob completely anticlockwise.
8. Check that the high pressure valve is closed.
9. Press the Engine on/off  button on the eControl+.
10. Let the engine idle.
11. Open the high pressure valve.
12. Press the High pressure on/off  button on the eControl+.  
All the water is now pumped out of the high pressure hose.
13. Close the high pressure valve when antifreeze comes out of the high pressure hose. You will see that the water turns blue.
14. Let the engine run a while longer. All the pipes now fill with antifreeze.
15. Press the High pressure on/off  button on the eControl+.



16. Press and hold the Engine on/off  button on the eControl+ for at least one second:  
The engine is now stopped.

**NOTE**

**When pumping out the water, there is no need to place a spray nozzle or spray gun on the high pressure hose.**

The machine is now ready for departure.

**Removing antifreeze**

Complete the following procedure to remove the antifreeze from the lines:

1. Start the machine (see section 'Starting the engine').
2. Prepare a reservoir or jerrycan.
3. Pump all the antifreeze through the high pressure hose to the reservoir or jerrycan. The antifreeze can then be used again next time.
4. Check that the antifreeze has not been diluted too much. If the antifreeze is diluted too much, the high pressure section of the machine is not sufficiently protected against freezing.
5. If the antifreeze has been diluted too much, take it to your municipal recycling collection point for disposal.
6. Stop the machine.
7. Prepare it for use (see section 'Checks before departure').



## 5 Operation: extra functions

### 5.1 Introduction

In this chapter we describe the various extra functions. First we discuss the machine's pulsator, reels, hose counter and electronic water level control. Then we discuss the eco mode and the management function of the eControl+. Finally, we describe the optional work lights.

### 5.2 Pulsator

#### 5.2.1 Introduction

The purpose of the pulsator is to reach the blockage in the sewer pipe faster with less water consumption. Use the pulsator to get to the blockage more quickly or in case of stubborn blockages.

#### Construction

The high pressure pump has three cylinders. In normal use, the three cylinders generate sequential pulses, which produces a continuous flow. When one of the three strokes is stopped, this results in a pulsating water flow.

#### 5.2.2 Manual operation pulsator

- > Open the three-way ball valve to start the pulsator.
- > Close the three-way ball valve to stop the pulsator.

Stop the pulsator when you reach the blockage. Then continue as described in section '*Unblocking a sewer*'.

#### 5.2.3 Starting the pulsator with the eControl+

You can only use this function if it is available on the eControl+ and if the vehicle engine is running.

Perform the following operations:

- > Turn the navigation knob clockwise and move the navigation bullet to the Pulsator position:

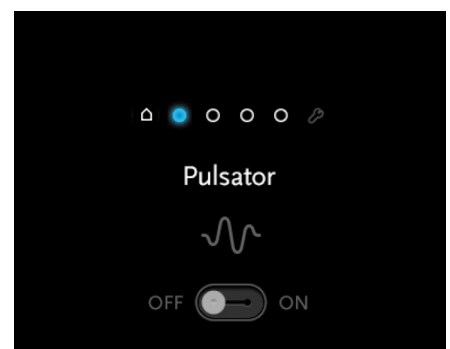

- > Press the navigation knob to activate the pulsator:

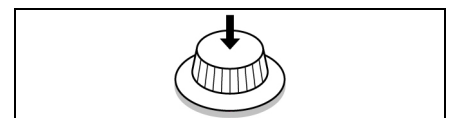

The navigation bullet now goes out and the pulsator icon lights up blue.

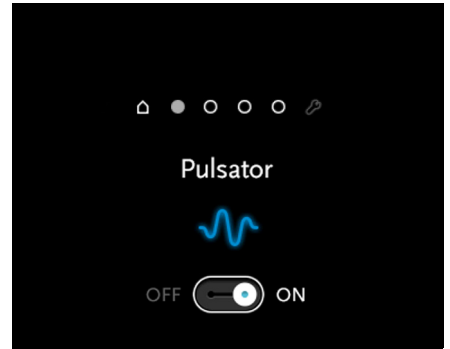

- > Turn the navigation knob clockwise:

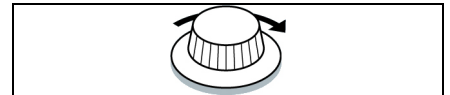

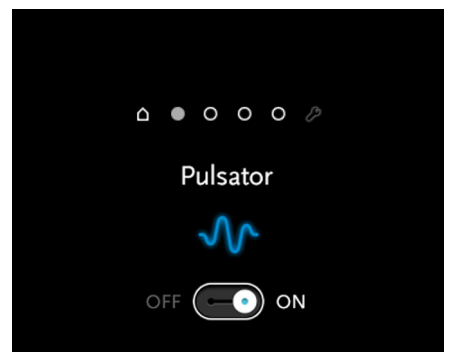

The text 'ON' is now shown below Pulsator.

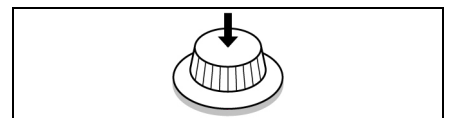

- > Press the navigation knob to activate the pulsator:



The  icon will now light up.

- > Press the High pressure on/off  button:  
See section '*Starting spraying*'.

### 5.2.4 Stopping the pulsator with the eControl+

Perform the following operations:

1. Press the High pressure on/off  button:  
See section '*Stopping spraying*'.
2. Turn the navigation knob clockwise and move the navigation bullet to the Pulsator position:

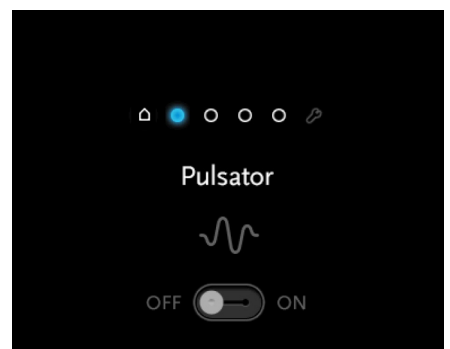

3. Press the navigation knob to activate the pulsator:

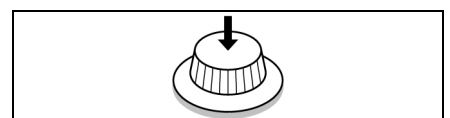

The navigation bullet now goes out and the pulsator icon lights up blue.

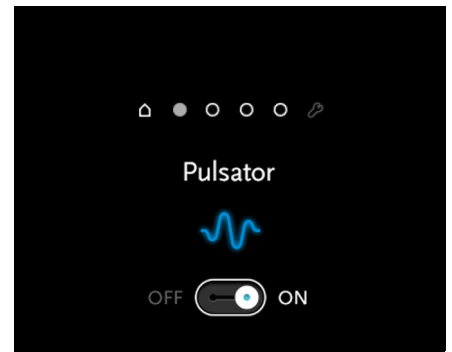

4. Turn the navigation knob anticlockwise:

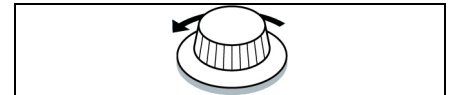

The text 'OFF' is now shown below Pulsator.

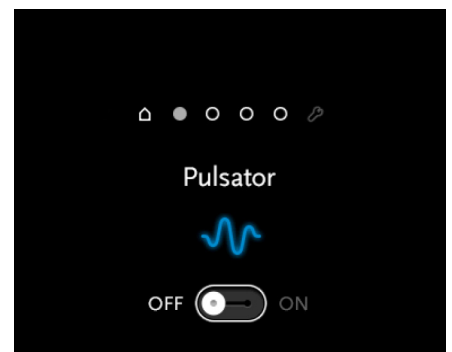

5. Press the navigation knob to deactivate the pulsator:

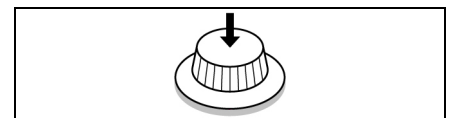

The pulsator icon  now goes out. The navigation bullet lights up blue.

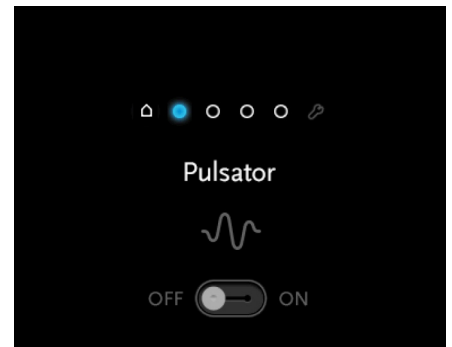

### 5.2.5 Setting the speed with the eControl+ when the pulsator is switched on

When the pulsator is on, perform the following operations to set the speed:

1. Press the navigation knob to deactivate the pulsator:

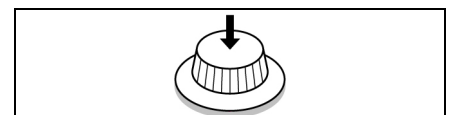

The pulsator icon now goes out and the navigation bullet lights up blue:

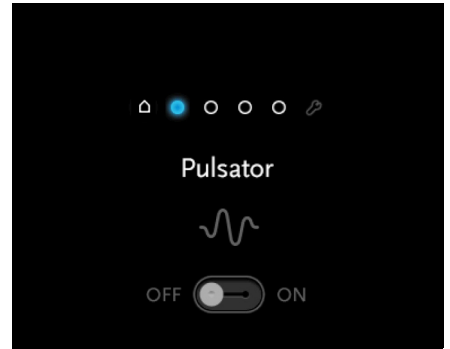

2. Go to the Home screen:  or

- press the engine symbol: 

The tachometer will now light up:

3. Turn the navigation knob to increase (clockwise) or decrease (anticlockwise) the speed:

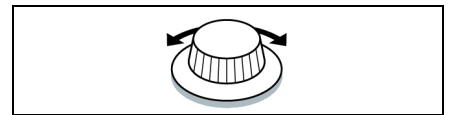
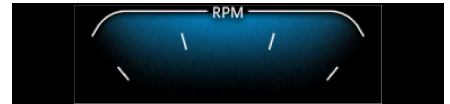

### 5.2.6 Starting the pulsator with the Riomote control

Perform the following operations:

1. Start the engine with the Riomote control (see section '*Starting the engine with the Riomote control*').
2. Set the PULSE rocker switch to the 'Pulsator ON' position (rocker switch up).

**NOTE**

The pulsator can only be operated with the 11-channel Riomote control.

### 5.2.7 Stopping the pulsator with the Riomote control

Set the PULSE rocker switch to the 'Pulsator OFF' position (rocker switch down).

## 5.3 Electric swivel arm latch

### Location:

The electric swivel arm latch is located under the high pressure reel at the end of the first hose guide bracket.

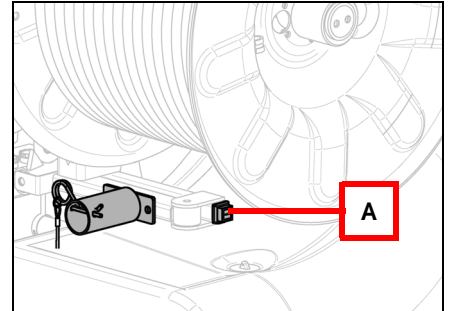

### Use

1. Press button A: Swivel arm released.
2. Swing the swivel arm to the desired position.
3. Release button A: Swivel arm fixed.



## 5.4 Reel

### 5.4.1 Safety

	<p><b>WARNING!</b></p> <p>There is a danger of pinching/crushing during reel operation! You may only operate the reels if there are no other people in the work area. This is YOUR responsibility.</p> 
---	--

### 5.4.2 Hydraulically reeling high pressure hose in/out

	<p><b>NOTE</b></p> <p>Water can still come out of the high pressure hose while reeling it in!</p>
---	---

The control lever has four positions:

- A: Reeling in
- B: Reel hold
- C: Reel out
- D: Reel freewheel

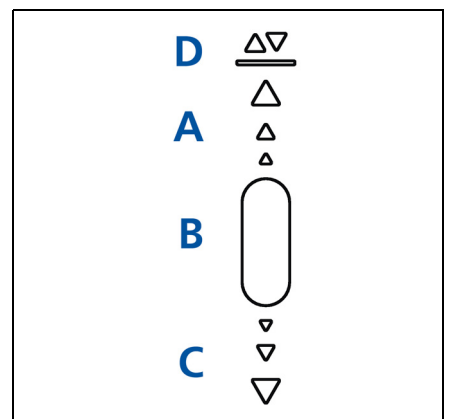

Push the control lever upwards to reel in the high pressure hose:

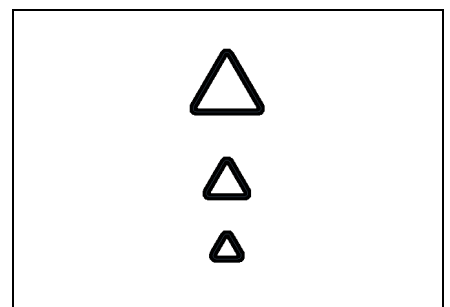



Push the control lever downwards to reel out the high pressure hose:  
The control lever also allows you to control the speed of reeling in/out.

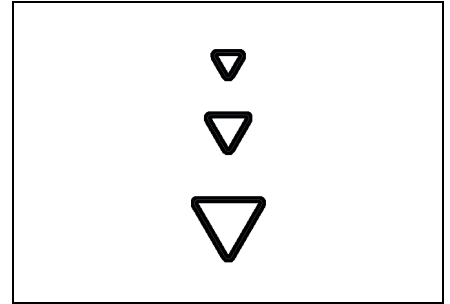

### 5.4.3 Manually reeling high pressure hose out

To switch off the hydraulic drive, move the control lever to the  position. You can now manually reel out the high pressure hose.



#### **WARNING!**

- Never fasten the lever in position in any way whatsoever!
- Always operate the control lever with one hand. With your other hand, guide the high pressure hose to its destination using the hose guide (option).

### 5.4.4 Hose guide

#### **Purpose**

#### **NOTE**

**ALWAYS** use the hose guide when reeling in the high pressure hose hydraulically.

The hose guide has two purposes:

1. Guiding the high pressure hose into the sewer.
2. Carefully winding the high pressure hose around the drum.

#### **Operation**

1. Insert or slide the high pressure hose through the opening of the sliding element.
2. Move the hose guide back and forth. This is how you wind the high pressure hose around the drum.

#### **After use**

#### **Advantages**

Use of the hose guide provides the following advantages:

- > improved work safety
- > more freedom of movement
- > no dirty hands
- > the high pressure hose lasts longer
- > the high pressure hose remains cleaner

1. Swing back the hose guide.
2. Secure the hose guide.

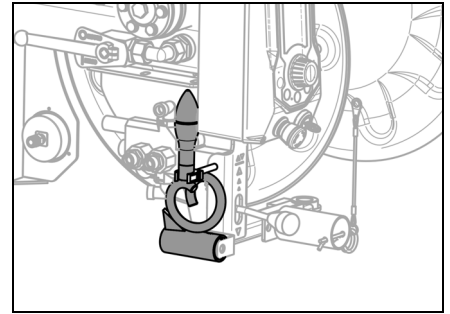

### 5.4.5 Reeling high pressure hose in/out with the eControl+

You can only use this function if it is available and the engine is running. Perform the following operations to reel the high pressure hose in/out:

1. Press the navigation knob to activate the navigation menu:
2. Turn the navigation knob clockwise and move the navigation bullet to the Reel position:

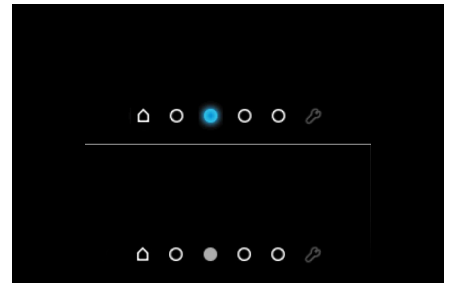
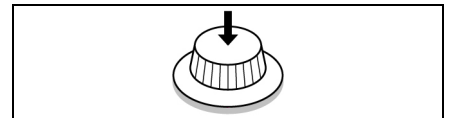

3. Press the navigation knob to activate the high pressure reel:

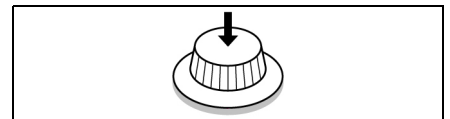

The navigation bullet will now go out.  
The high pressure reel icon now lights up blue:

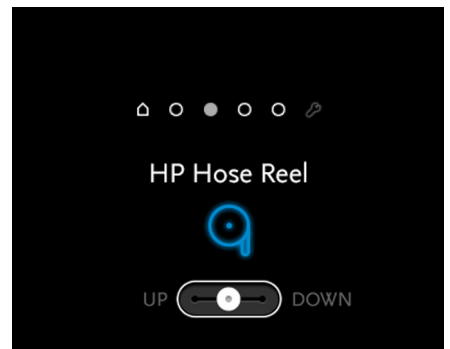

4. Turn the navigation knob anticlockwise to reel in the high pressure hose:

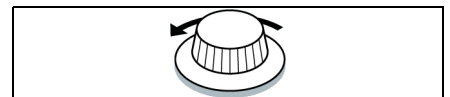

OR:

- Turn the navigation knob clockwise to reel out the high pressure hose:

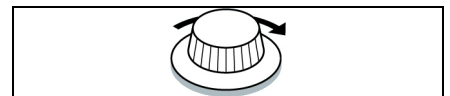
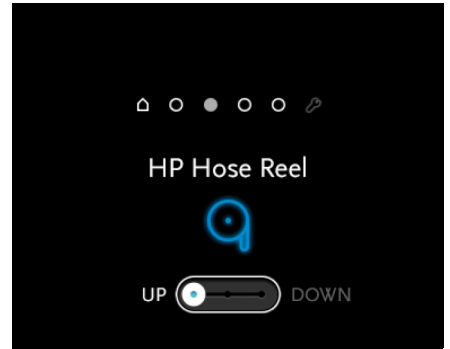

- Press the navigation knob to start reeling in or out:

The  icon lights up when you press the navigation knob.

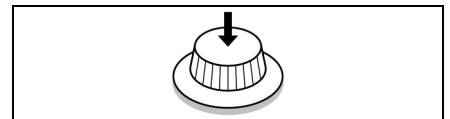
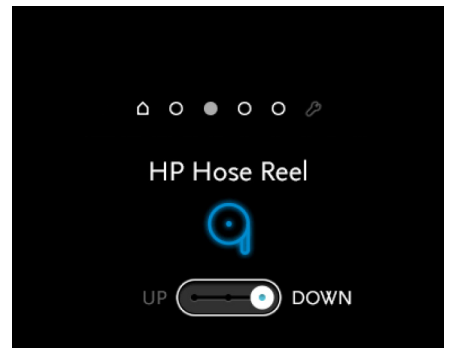

- Release the navigation knob to stop reeling in or out. The  icon disappears when you release the navigation knob.

**Switching off reeling in/out with the eControl+**

- Turn the navigation knob to the centre (neutral) position:

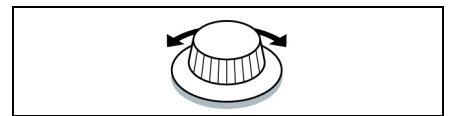

- Press the navigation knob to deactivate the high pressure reel:

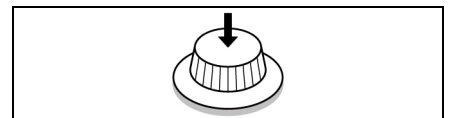

The high pressure reel icon now goes out.

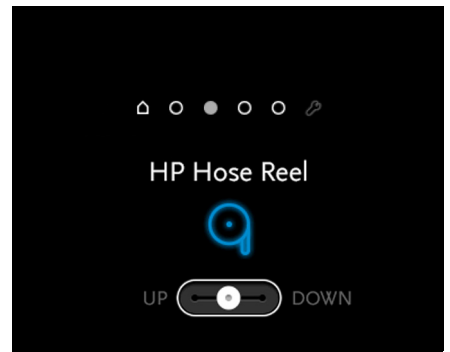

The navigation bullet turns blue:

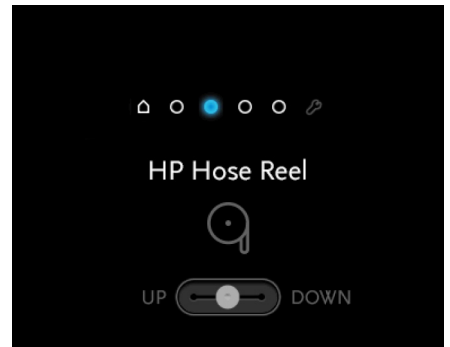

### 5.4.6 Manually reeling out high pressure hose controlled by eControl+

Your machine may be equipped with a mechanical freewheel locking option. This allows you to set the high pressure reel to the 'freewheel' or 'locked' position.

#### Freewheel

To manually reel out the high pressure hose, move the lever to the position shown below:

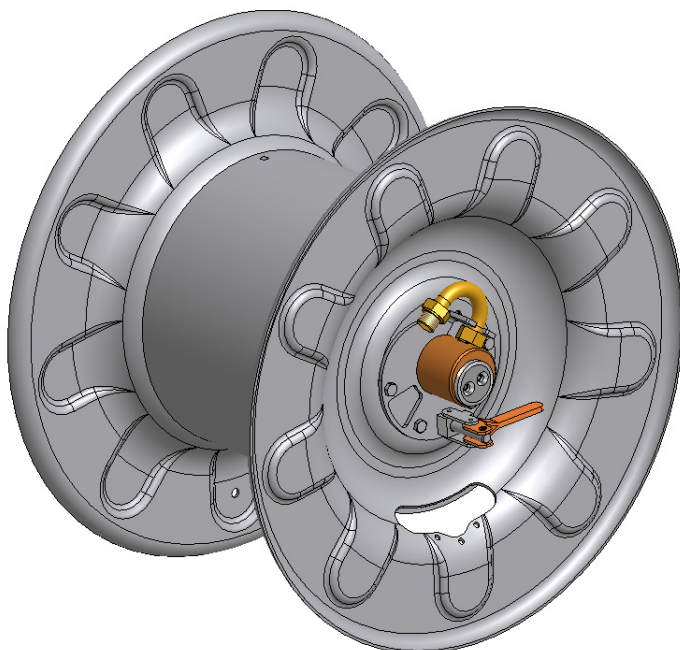

The locking pin is now released and the high pressure reel can rotate freely, without resistance.

### Locked

To reel the high pressure hose in/out with the eControl+, move the lever to the position shown below:

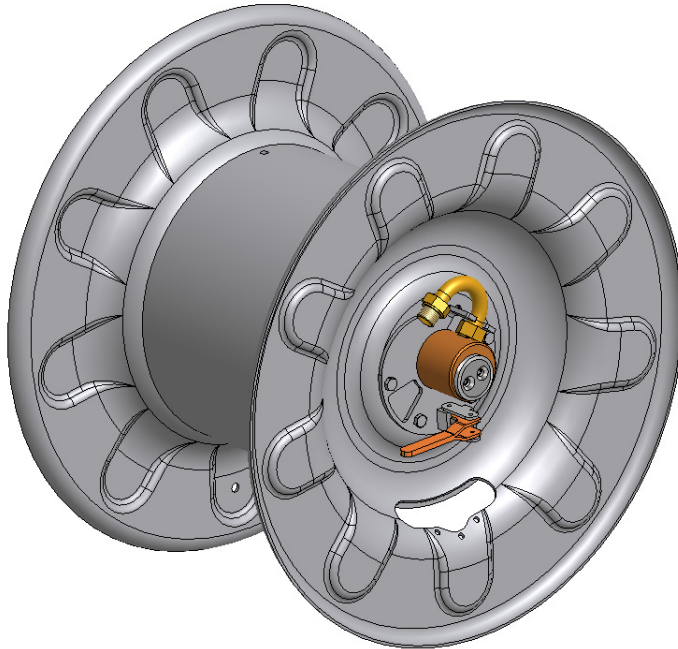

The pin locks and you can reel with the eControl+ again.

## 5.4.7 Reeling in/out with the Riomote control

### Reeling in

1. Check that the engine is running.
2. If not, start the engine with the Riomote control (see section '*Starting the engine with the Riomote control*').
3. Set the rocker switch to the 'Reel in high pressure hose' position (rocker switch up).

### Reel out

1. Check that the engine is running.
2. If not, start the engine with the Riomote control (see section '*Starting the engine with the Riomote control*').
3. Set the rocker switch to the 'Reel out high pressure hose' position (rocker switch down).

#### NOTE

The 'Reel in/out' function may be available on the 9- AND 11-channel Riomote control.  
This depends on the customer's preferences.

## 5.5 Hose meter counter eControl+

### 5.5.1 Introduction

The hose counter indicates how many metres of high pressure hose is in the sewer.

#### Things to keep in mind during use

Keep the following in mind when using the hose counter:

- > The hose counter only measures when the ignition is turned on and the emergency stop is off.
- > The Riomote control must therefore be paired!
- > Make sure the hose is always rolled up completely when you turn the ignition on. This is important, because it is the reference position for the measurements.
- > Make sure the hose is always stretched tight, because the measurement takes place on the reel.
- > The count is in whole metres with a theoretical maximum deviation of one metre when the hose is tightly coiled.

### 5.5.2 Activating the eControl+

1. Turn the key of the eControl+ a quarter turn clockwise to position 1.
2. After a while this screen will be shown:
3. The hose counter is now directly available.

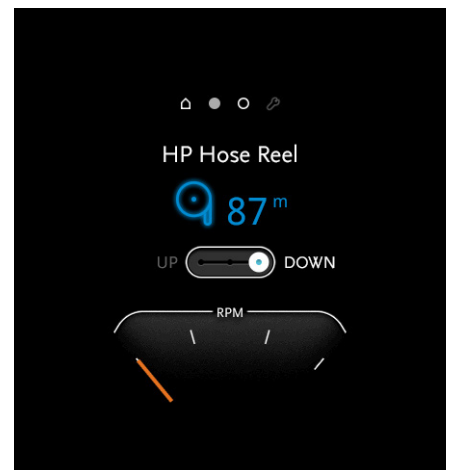

### 5.5.3 Switching the hose counter on and off

The hose counter is switched on as follows:

1. Select the management function (see section 'Management function eControl+')
2. Press the navigation knob:
3. Select Hose Counter.
4. Press the navigation knob.
5. Press the navigation knob again. Hose Counter On turns blue.

The hose counter is now switched on.

The hose counter is switched off as follows:

1. Turn the navigation knob and select Off.
2. Press the navigation knob.
3. Select Set.
4. Select Back.

You are now back on the home screen. The hose counter is now switched off.

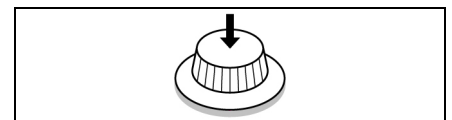

### 5.5.4 Resetting hose counter to 0 metres

If you reset the hose counter to 0 metres, you can make a measurement from any point. Do this as follows:

1. Make sure the hose is completely rolled up.
2. Press the navigation knob.
3. Select Reset and press the navigation knob. The hose counter now shows 0.
4. Select Back and press the navigation knob. You are now back on the home screen.

### 5.5.5 Switching between 'metres' and 'feet'

The hose counter is set to 'metres' by default. You can switch between 'metres' and 'feet' as follows:

1. Select the management function (see section '*Management function eControl+*')
2. Press the navigation knob:
3. Select Hose Counter and press the navigation knob.
4. Press the navigation knob again.
5. Select Counter Unit.
6. Press the navigation knob again. Counter Unit metre turns blue.
7. Turn the navigation knob and select ft.
8. Press the navigation knob.
9. Select Set.
10. Select Back.

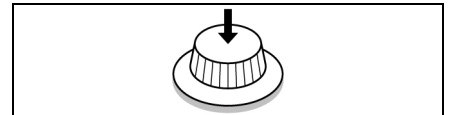

You are now back on the home screen. The hose counter is now set to 'feet' instead of 'metres'.

#### NOTE

If you use the hose counter, you can no longer activate the home screen of the eControl+. The speed can then only be activated by briefly pressing the Engine on/off button.

## 5.6 Electronic water level control

The purpose of the electronic water level control is to be able to continuously top up during spraying.

### Principle of operation

There is a float in the water tank. This switch controls the solenoid valve in the filling line. When the water level is too high, the solenoid valve closes. When the water level is too low, the solenoid valve opens. You are therefore assured of water during spraying.

### Filling the water tank

1. Connect a filling hose to the coupling of the filling line on the machine.
2. Turn on the mains water supply tap.
3. Turn on the switch for the water level control.

The water tank is now filled with water.

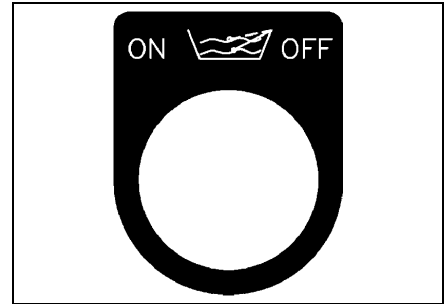

### Stopping filling

1. Close the mains water supply tap.
2. Press the button of the solenoid valve. This releases the pressure from the filling line.
3. Disconnect the filling hose from the coupling of the filling line.

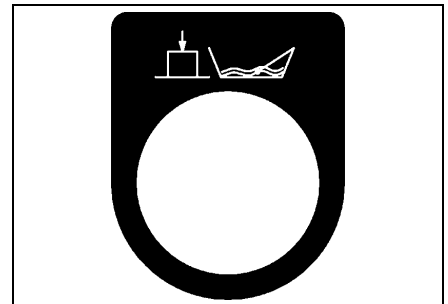

## 5.7 Suction venturi

### Purpose:

The suction venturi enables you to fill the water tank with surface water.

### Principle of operation:

The water in the water tank is pumped through the suction venturi. A vacuum forms in the suction venturi. This vacuum draws in the surface water. All the water mixes and ends up in the water tank.

### Preparation:

You should always check that there is still water in the water tank. If not, the suction venturi cannot function.



**Note:**

If your machine is equipped with dry-running protection, you can always use the suction venturi. This is because the dry-running protection always leaves some water in the water tank.

**Starting suction:**

- > Connect the coupling of the filling hose to the coupling of the suction venturi.
- > Place the strainer of the suction hose in the surface water.
- > Check that the high pressure valve to the high pressure hose is closed.
- > Start the machine.
- > Switch on the high pressure pump, if necessary.
- > Set the lever of the high pressure valve to 'suction venturi'.

The water tank is now filled with surface water.

**Stopping suction:**

- > Set the lever of the high pressure valve to the other position.
- > Stop the machine.
- > Disconnect the suction hose and put it away.

## 5.8 Eco mode eControl+

### 5.8.1 Introduction

If the machine has an eco mode, it is always switched on as standard. The eco mode can only be used if it is available and the engine is running.

There are two variants of the eco mode, which we will discuss separately below: Eco Start/Stop and Eco Stop.

### 5.8.2 Switching eco mode on and off

1. Turn the navigation knob clockwise and move the navigation bullet to the eco mode position:

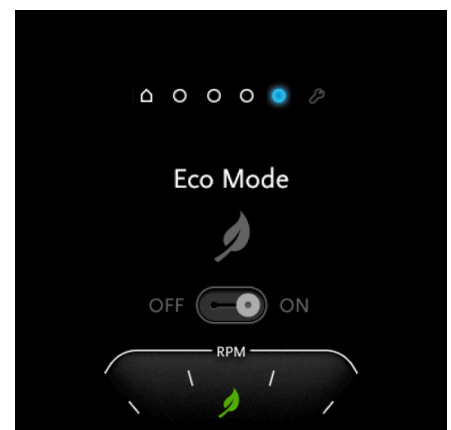
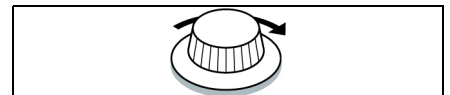

2. Press the navigation knob to activate the eco mode:

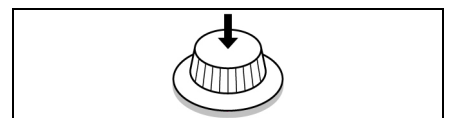

The navigation bullet now goes out and the eco mode icon lights up green:

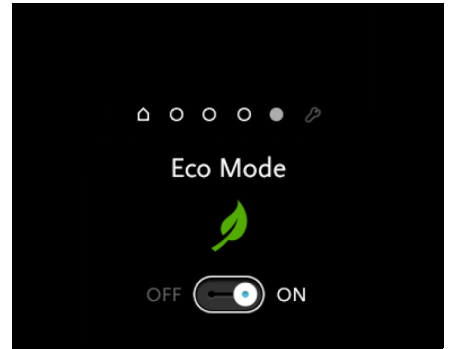

- 3. Turn the navigation knob anticlockwise to switch off eco mode:

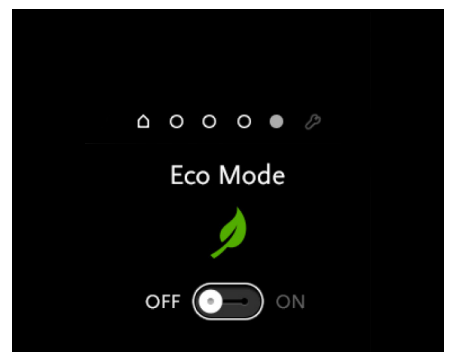
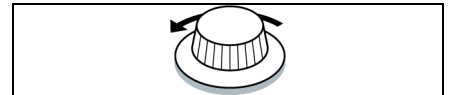

- 4. Press the navigation knob to deactivate eco mode:

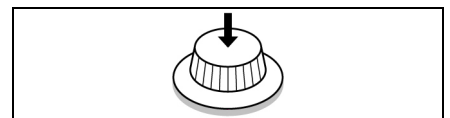

The eco mode icon now goes out and the navigation bullet lights up blue:

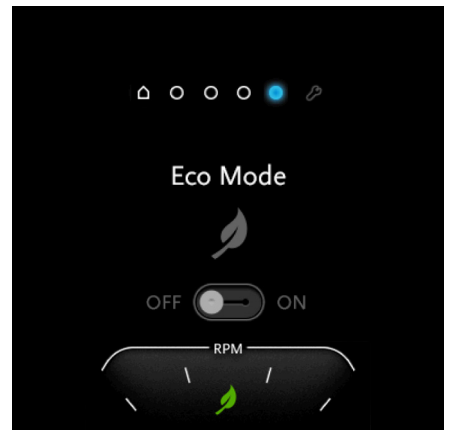

After two seconds the text 'Hours Total' is displayed:

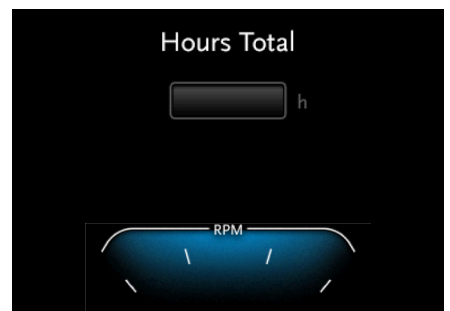

### 5.8.3 ECO Start/Stop

This variant of the eco mode allows the engine to be stopped when spraying is stopped and automatically restarted when spraying is restarted.

#### Stopping the engine

1. Press the High pressure on/off button: 

Now the following happens:

  - The spraying of the water is stopped.
  - The engine speed drops.
  - If no action is taken, the engine stops after thirty seconds.

#### Starting the engine

The engine can be started in two ways:



1. Press the High pressure on/off  button:
 

Now the following happens:

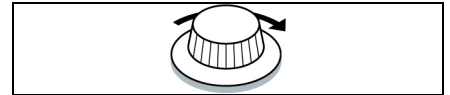
  - The engine is started if necessary.
  - Water comes out of the high pressure hose.
2. Increase the speed for higher pressure and more water: turn the navigation knob clockwise:



OR:

1. Press the Engine on/off  button:
2. Press the High pressure on/off button: 

Now water comes out of the high pressure hose.
3. Increase the speed for higher pressure and more water: turn the navigation knob clockwise:

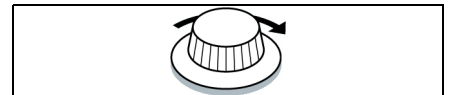

### 5.8.4 ECO Stop

This variant of the eco mode allows the engine to be stopped when spraying is stopped but NOT automatically restarted when spraying is restarted.

#### Stopping the engine

Press the High pressure on/off button:

Now the following happens:

- > The spraying of the water is stopped.
- > The engine speed drops.
- > If no action is taken, the engine stops after thirty seconds.

#### Starting the engine

With this variant of eco mode, the engine can only be started in one way:

1. Press the Engine on/off button:
2. Press the High pressure on/off button:
 

Now water comes out of the high pressure hose.
3. Increase the speed for higher pressure and more water: turn the navigation knob clockwise:

### 5.9 Management function eControl+

The management function of the eControl+ allows you to manage fault messages, check whether your machine is in need of maintenance and view the software version.

Activate the management function as follows:

1. Turn the navigation knob clockwise and move the navigation bullet to the 'Management' position:

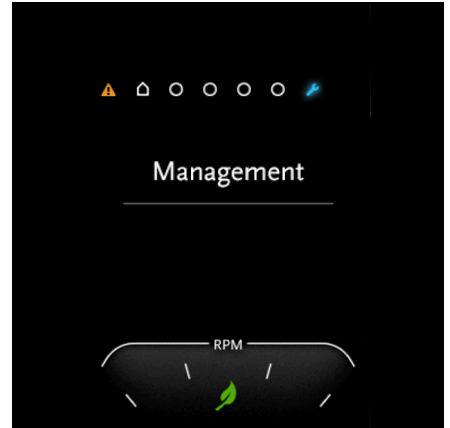

2. Press the navigation knob to activate the management function:

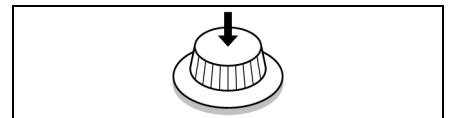

Now the navigation bullet will go out and the line under 'Management' turns white:

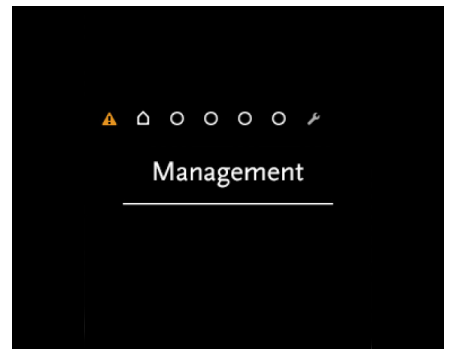

#### Software version

Press the navigation knob to display the menu with the software settings:  
Press the navigation knob again to close this menu.

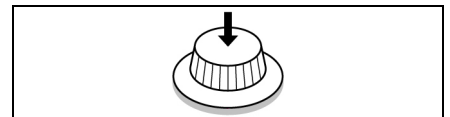

#### Maintenance interval

If you want to know when your machine will need maintenance again, do the following:

Press the navigation knob:

The following is now displayed:

- > the number of days until the next maintenance service
- > the number of hours until the next maintenance service

Press the navigation knob again to close this menu.

Scroll to Back with the navigation knob and press the navigation knob to make the navigation bullets visible again.

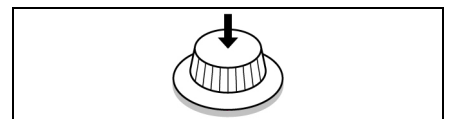

The machine displays the following message after starting if periodic maintenance is required:

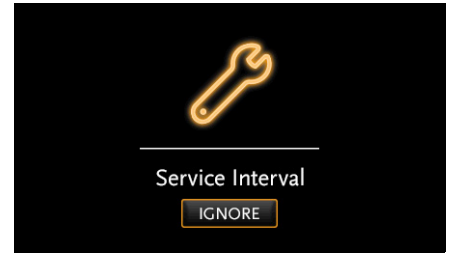

Press the navigation knob to clear the message:

You can now continue working with the machine.

The next time the machine is started, the message will be displayed again.

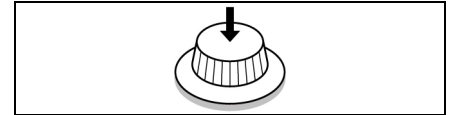



## 6 Maintenance

### 6.1 Safety instructions

ALWAYS observe the following points during maintenance, inspection and installation:

- > You may only perform this work if you are qualified to do so. You must have read and understood the user manual.
- > You may only work on the machine when it is not running.
- > You must stop the machine (take it out of service) correctly (see section '*Ending the work*').
- > Clean the pump if it has pumped liquids that could pose a health hazard.
- > When you have finished your work, IMMEDIATELY reinstall all safety and protection provisions and make them functional.
- > Follow all instructions before you start the machine again (see section '*Starting the engine*').



#### **WARNING!**

- Before you start any maintenance or repair work, take the following precautions:
- ALWAYS stop the engine first.
- Depressurize the system by opening the high pressure valve.
- If the spray gun is attached to the high pressure hose, squeeze the trigger.

### 6.2 Making changes to the machine

You may ONLY make changes to the machine if you have received written authorization from Rioned. The use of original replacement parts and Rioned-approved accessories is important for safety.

If you use other parts, Rioned is NOT liable for any consequential damage.

### 6.3 Maintenance schedule

The next scheduled maintenance is set to 360 days or 250 hours of operation on the eControl+. At the end of these 360 days (or 250 hours of operation, whichever comes first) a message appears on the eControl+ indicating that periodic maintenance is required (see section '*Management function eControl+*').

Maintain the various parts of the machine according to the following schedule:

<b>Check oil levels</b>	Before the work
<b>Clean water filter</b>	Before the work and when very dirty
<b>Check high pressure hose and other hoses</b>	Before the work
<b>Clean bodywork</b>	Weekly or when very dirty
<b>Poke the nozzle holes clean</b>	Every 50 hours of operation
<b>Lubricate moving parts</b>	Every 250 hours of operation or at least once every six months
<b>Clean pressure regulator</b>	Every 250 hours of operation or at least once every six months
<b>Change hydraulic oil</b>	Every 1000 hours of operation or once a year
<b>Clean suction valves of high pressure pump</b>	Once a year
<b>Clean pressure valves of high pressure pump</b>	Once a year
<b>Major scheduled maintenance</b>	Once a year
<b>Engine service</b>	See the maintenance manual for the engine

**NOTE**  
**All other parts must be replaced IMMEDIATELY when worn or defective!**

**Wear**

Insufficient or late maintenance can result in premature wear of the machine.

Other causes of premature wear are:

- > heat development caused by:
  - a. running the engine unnecessarily
  - b. not discharging water and/or
  - c. continuous circulation of the oil through the lines
- > lack of lubrication
- > contaminants in the high pressure pump
- > exceeding the maximum pressure
- > rust formation at standstill
- > running the machine while not cleaning

In the following sections, we first describe the maintenance of the machine per period.



## 6.4 Removal/installation of protective covers

### Removal:

1. Insert the key into the lock.
2. Turn the key clockwise.
3. Turn knob A a quarter turn to the right.
4. Turn knob B a quarter turn to the left.
5. Lift the cover slightly.
6. Remove the cover.

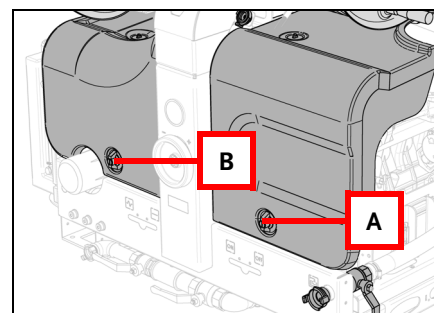

### Installation:

1. Insert the tabs of the cover into the corresponding slots.
2. Lower the front.
3. Turn knob A a quarter turn to the left.
4. Turn knob B a quarter turn to the right.
5. Turn the key anti-clockwise.
6. Remove the key.

#### NOTE

The maintenance of the engine is beyond the scope of this user manual. That information can be found in the documentation you received with the machine.

## 6.5 Maintenance before the work

The following parts must be checked or cleaned before the work:

### 6.5.1 Check oil levels

- > Check ALL the oil levels before the work.
- > Top up as required.

If the oil level has dropped, there is probably a leak in the system. In that case, do the following:

1. Check all the gaskets, connections and lines in the system concerned.
2. Repair the defects immediately.
3. Top up with the correct oil.

#### NOTE

Oil consumption may be slightly higher than normal during the break-in period (20 hours).

### 6.5.2 Clean water filter

Clean the water filter as follows:

1. Close the supply valve in the suction hose.
2. Unscrew the filter cap from the filter body.
3. Clean the filter screen and other contaminated parts of the filter.
4. Screw the filter cap back onto the filter body.
5. Open the supply valve in the suction hose.
6. Check the water filter for leaks.

Clean the water filter sooner if it is very dirty.

### 6.5.3 Check high pressure hose and other hoses

The high pressure hose may be damaged during use. Therefore perform the following checks:

- > Check the high pressure hose for wear and damage every time you reel it in.
- > Also check all the other hoses for wear and damage.
- > Check all the hoses and connections for leaks.

### 6.5.4 Maintenance of remote control

The remote control requires almost no maintenance, but the following aspects require your attention:

- > Make sure the on/off switch of the transmitter operates smoothly. It may stick if not kept clean, and may eventually stop working altogether.
- > Protect the transmitter from water/moisture.
- > Do not clean transmitter and receiver with a pressure washer or any other type of sprayer.
- > Charge and discharge the transmitter regularly.
- > Regularly disconnect the receiver's connector plug; otherwise it will stick in place, which will prevent proper operation.

## 6.6 Weekly maintenance

Clean the bodywork weekly. Use lots of water and automotive shampoo. The bodywork should be cleaned earlier if it is heavily soiled.

## 6.7 Maintenance every 50 hours of operation

The nozzle holes must be poked clean every 50 hours of operation:

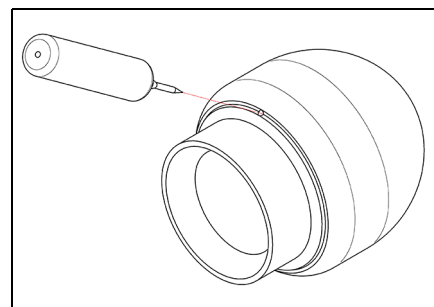

## 6.8 Maintenance every 250 hours of operation or at least once every six months

The following parts must be maintained every 250 hours of operation or at least once every six months:

### 6.8.1 Lubricate moving parts

The following parts must be lubricated every 250 hours of operation or at least once every six months:

- > all pivot points of the swivel arm
- > the latch of the swivel arm
- > the gears of the high pressure reel
- > the hose guide

### 6.8.2 Clean pressure regulator

- > Clean the pressure regulator every 250 hours of operation or at least once every six months.
- > Carefully remove all the sand.

#### NOTE

Proper maintenance considerably extends the service life of the pressure regulator!

#### Leakage, contamination or damage

If the high pressure valve is closed, you CANNOT read the pressure on the pressure gauge. You also CANNOT read the pressure on the pressure gauge if the spray gun is connected but the trigger is not pulled.

If the pressure gauge nevertheless shows a pressure reading, there is leakage or the non-return valve is dirty or damaged. In that case, do the following:

1. Turn off the machine.
2. Unscrew the hose coupling.
3. Clean or replace the non-return valve.
4. Check that the O-ring is still in good condition.
5. Check that the sealing ring is still in good condition.

## 6.9 Maintenance every 1000 hours of operation or at least once a year

The following parts must be maintained every 1000 hours of operation or at least once a year:

### 6.9.1 Change hydraulic oil

Change the oil in the hydraulic system every 1000 hours of operation (or at least once a year). Use oil from Rioned. P/N 71-003-000-046.

### 6.9.2 Clean suction valves of high pressure pump

Clean the suction valves of the high pressure pump once a year.  
See accompanying annex for more information.

### **6.9.3 Clean pressure valves of high pressure pump**

Clean the pressure valves of the high pressure pump once a year.  
See accompanying annex for more information.

### **6.9.4 Major scheduled maintenance**

Have Rioned technical service inspect and maintain the machine once a year. This will ensure the continued good performance and long service life of the machine.

## 7 Malfunctions

### 7.1 Fault messages, eControl+

The eControl+ can display various fault messages. They are also listed in the section about the management function (see section '*Management function, eControl+*'). Each of these fault messages, and what you should do if they appear, is explained hereafter.

#### 7.1.1 Emergency stop

If the emergency stop is pressed, the following message appears:

##### Consequences for systems:

- > The engine, high pressure pump, vacuum system, pulsator, reel and/or hose counter are switched off.
- > The eco mode is switched on.

##### Solution:

Unlock the emergency stop by turning the button to the left or right. You can then restart the machine (see section '*Starting the engine with the eControl+*' and '*Starting the engine with the Riomote control*').

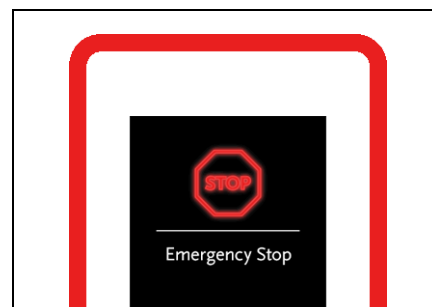

#### 7.1.2 Engine temperature too high

If the engine temperature becomes too high, the following message appears:

##### Consequences for systems:

1. The engine, high pressure pump, vacuum system, pulsator, reel and/or hose counter are switched off.
2. The eco mode remains unchanged.

##### Solution:

1. Press the navigation knob to clear the message:
2. Let the engine cool. Work can continue when the engine has cooled down sufficiently.

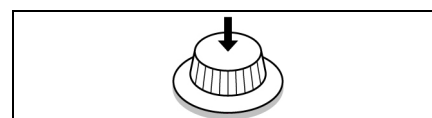
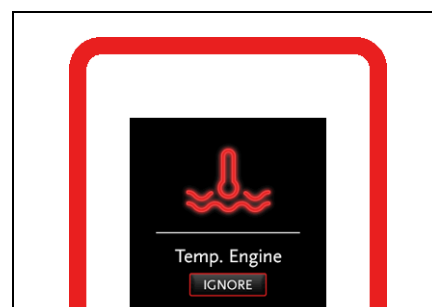

#### 7.1.3 Heat exchanger temperature too high

If the temperature of the heat exchanger becomes too high, the following message appears:

##### Consequences for systems:

1. The engine, high pressure pump, vacuum system, pulsator, reel and/or hose counter are switched off.
2. The eco mode remains unchanged.

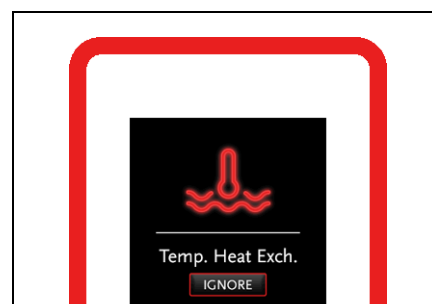

**Solution:**

1. Press the navigation knob to clear the message:
2. Let the heat exchanger cool down. Work can continue when the heat exchanger has cooled down sufficiently.

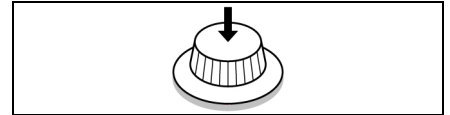

### 7.1.4 Hydraulic oil temperature too high

If the temperature of the hydraulic oil becomes too high, the following message appears:

**Consequences for systems:**

1. The engine, high pressure pump, vacuum system, pulsator, reel and/or hose counter are switched off.
2. The eco mode remains unchanged.

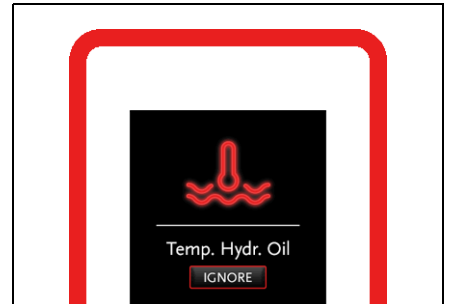
**Solution:**

1. Press the navigation knob to clear the message:
2. Let the hydraulic oil cool down. Work can continue when the hydraulic oil has cooled down sufficiently.

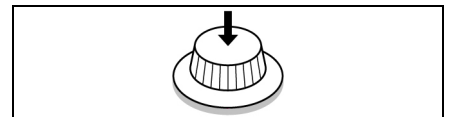

### 7.1.5 Hydraulic oil level too low

If the hydraulic oil level becomes too low, the following message appears:

**Consequences for systems:**

1. If the engine is running, it will go to idle.
2. The high pressure pump, vacuum system, pulsator, reel and/or hose counter are switched off.
3. The eco mode remains unchanged.

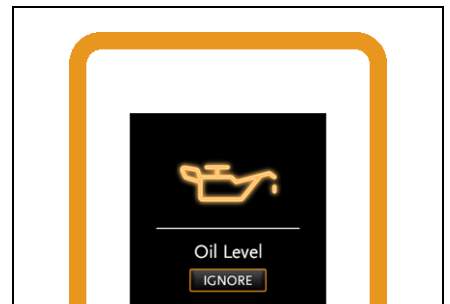
**Solution:**

1. Press the navigation knob to clear the message:
2. Top up hydraulic oil (P/N 71003500046).  
Work can continue after sufficient oil has been added. This can be measured via the dipstick or seen on the sight glass, depending on which version is fitted.

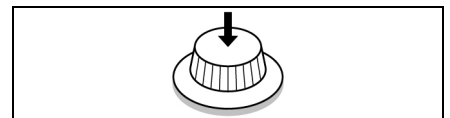

### 7.1.6 Coolant level too low

If the coolant level becomes too low, the following message appears:

**Consequences for systems:**

1. The engine, high pressure pump, vacuum system, pulsator, reel and/or hose counter are switched off.
2. The eco mode remains unchanged.

**Solution:**

1. Press the navigation knob to clear the message:
2. Top up the coolant (P/N 71004000000).  
Work can continue after sufficient coolant has been added. This can be seen on the coolant tank.

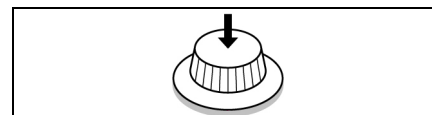
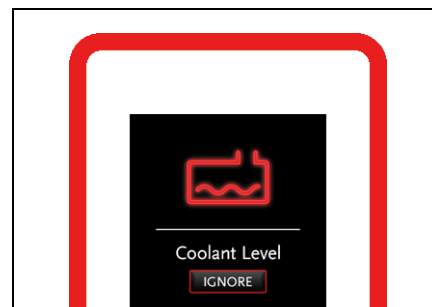

### 7.1.7 Battery voltage too low

If the battery voltage becomes too low, the following message appears:

**Consequences for systems:**

1. The engine, high pressure pump, vacuum system, pulsator, reel and/or hose counter remain unchanged.
2. The eco mode also remains unchanged.

**Solution:**

1. Press the navigation knob to clear the message:
2. Check all wiring for damage and connections. Repair or replace them if a problem is found.
3. Check the charging voltage of the alternator on the engine.
4. Charge the battery fully or replace it.

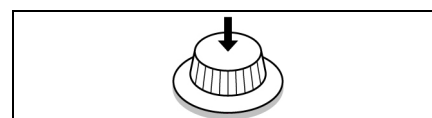
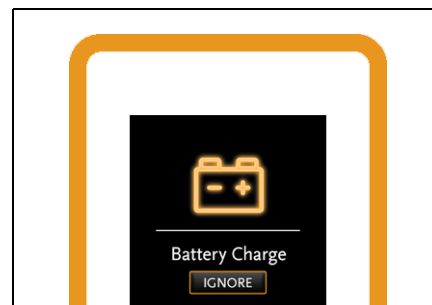

### 7.1.8 Water level too low

If the machine is in danger of running dry, the following message appears:

**Consequences for systems:**

1. If the engine is running, it will go to idle.
2. The high pressure pump, vacuum system, pulsator, reel and/or hose counter are switched off.
3. The eco mode remains unchanged.

**Solution:**

1. Press the navigation knob to clear the message:

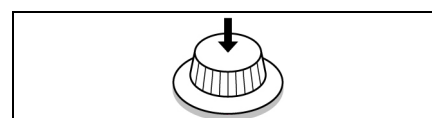
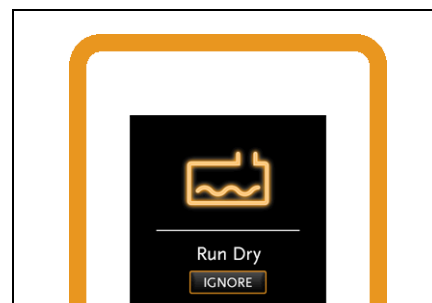

2. The high pressure LED on the eControl+ starts flashing blue:
3. Press and hold the navigation button until the message disappears.
4. Fill the water tank with about 20 litres of water (see section 'Before starting').

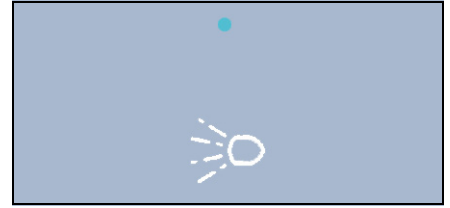

### 7.1.9 Water level too high

Only available if the electronic water level control function is present.

If the water level is too high, the following message appears:

**Consequences for systems:**

1. The engine, high pressure pump, vacuum system, pulsator, reel and/or hose counter remain unchanged.
2. The eco mode also remains unchanged.

**Solution:**

Press the navigation knob to clear the message:

This message also disappears if the water level drops below the sensor when water is drawn off.

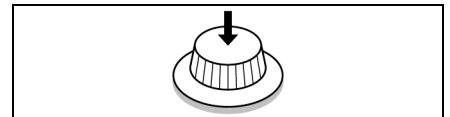
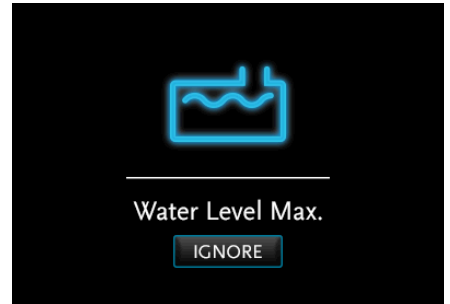



### 7.1.10 Troubleshooting

Below you will find a list of faults, their possible causes and the corresponding solution for each cause.

Fault	Cause	Solution
Engine will not start or stops suddenly.	Fuel tank empty.	Refill the fuel tank.
	Main or accessory fuse blown.	<ol style="list-style-type: none"> <li>1. Replace defective fuse.</li> <li>2. Restart engine.</li> <li>3. If the fuse blows again, contact Rioned.</li> </ol>
	Battery voltage too low.	Charge the battery or replace the battery
	Air in fuel line.	Bleed air at engine.
	Riomote control not switched on.	<ol style="list-style-type: none"> <li>1. Turn on the Riomote control.</li> <li>2. Repeat procedure from section '<i>Preparation for use</i>'.</li> </ol>
	Riomote control Battery flat.	Charge battery or replace battery.
	Water tank empty.	Fill water tank.
	Water temperature too high.	Fill water tank or let water cool.
	Hydraulic oil temperature too high.	Let oil cool.

<b>Fault</b>	<b>Cause</b>	<b>Solution</b>
High pressure pump does not produce required pressure.	Water tank empty.	Fill water tank.
	Supply valve to water filter closed.	Open supply valve.
	Water filter restricted.	Stop machine. Clean water filter.
	Air in high pressure pump.	<ol style="list-style-type: none"> <li>1. Let the machine run several minutes with the high pressure valve open.</li> <li>2. If the fault is not cleared, contact Rioned.</li> </ol>
	Suction valves of high pressure pump seized.	<ol style="list-style-type: none"> <li>1. Carefully free the valves.</li> <li>2. Remove any lime scale build-up.</li> </ol>
	Suction valves of high pressure pump worn.	Contact Rioned.
High pressure pump does not produce required pressure.	Water tank empty.	Fill water tank.
	Supply valve to water filter closed.	Open supply valve.
	Water filter restricted.	Stop machine. Clean water filter.

Fault	Cause	Solution
Water pressure fluctuates greatly.	Level in water tank too low.	<ol style="list-style-type: none"> <li>1. Stop machine.</li> <li>2. Top up water tank.</li> <li>3. Restart engine.</li> </ol>
	Supply valve not opened far enough.	Open supply valve completely.
	Water filter restricted.	<ol style="list-style-type: none"> <li>1. Stop machine.</li> <li>2. Clean water filter.</li> </ol>
	High pressure pump draws in air.	<ol style="list-style-type: none"> <li>1. Stop machine.</li> <li>2. Check all the hoses and connections for leaks.</li> <li>3. Replace defective components.</li> </ol>
	Spray nozzle restricted or worn.	<ol style="list-style-type: none"> <li>1. Stop machine.</li> <li>2. Check spray nozzle condition.</li> <li>3. Poke through nozzle holes or</li> <li>4. Replace worn nozzle.</li> </ol>
	Pressure valves restricted with lime scale or worn.	<ol style="list-style-type: none"> <li>1. Stop machine.</li> <li>2. Check condition of pressure valves.</li> <li>3. Descale pressure valves or</li> <li>4. Replace pressure valves.</li> </ol>
	High pressure pump sealing ring worn.	<ol style="list-style-type: none"> <li>1. Stop machine.</li> <li>2. Replace sealing ring.</li> </ol>
	Ceramic pistons in high pressure pump damaged.	Contact Rioned.
Pressure regulator internally restricted or damaged.	Contact Rioned.	

<b>Fault</b>	<b>Cause</b>	<b>Solution</b>
High pressure hose does not reel in.	Control slider lever in 'Manual' position.	Move control slider lever to other position.
	Oil tank for hydraulic system almost empty.	<ol style="list-style-type: none"> <li>1. Top up oil tank for hydraulic system.</li> <li>2. Check system for leaks.</li> </ol>
	Drive chain not sufficiently tensioned.	Tighten chain.
	Set operating pressure is too low.	Set higher operating pressure, if possible.
	Hydraulic system damaged.	Contact Rioned.

<b>Fault</b>	<b>Cause</b>	<b>Solution</b>
No response with Riomote control switched on.	No power.	Charge battery of Riomote control.
		Fit new battery in Riomote control.
		Check contact terminals for damage/contamination.
		<ol style="list-style-type: none"> <li>1. Check fuses.</li> <li>2. Replace any blown fuses.</li> </ol>
		In the case of repeated faults, contact Rioned.
	Riomote control not switched on.	Press the START button, bottom right of Riomote control.
Riomote control out of range of the receiver.	Bring Riomote control within range of the receiver.	

Fault	Cause	Solution
LED next to START button at bottom right of the Riomote control flashes after a short period of operation.	Battery not charged or defective.	<ul style="list-style-type: none"> <li>• Fully charge the battery or</li> <li>• Replace battery.</li> </ul>
		Check whether charging process is working correctly.
		<ul style="list-style-type: none"> <li>• Check battery contact terminals or</li> <li>• Clean battery contact terminals.</li> </ul>
Indications on Riomote control are good, but functions are not performed.	Emergency stop pressed.	Turn button left or right to unlock emergency stop.
	Receiver has no power.	<ol style="list-style-type: none"> <li>1. Check fuse.</li> <li>2. Replace any blown fuse.</li> </ol>
	No connection to receiver.	Check all indicator lights for all functions.
Command via Riomote control not performed.	Open in electrical circuit.	<ol style="list-style-type: none"> <li>1. Check all plug connections.</li> <li>2. Push plugs in or</li> <li>3. Connect detached plugs.</li> </ol>
		Check all indicator lights for all functions.
	Receiver defective.	Contact Rioned.



# 8 Index

## A

<b>antifreeze</b>	
filling water tank with .....	48
removing .....	49

## B

<b>battery voltage too low</b> .....	79
--------------------------------------	----

## C

<b>changing hydraulic oil</b> .....	75
<b>checking hoses</b> .....	74
<b>checking oil levels</b> .....	73
<b>checks before departure</b> .....	37
<b>checks before starting the work</b> .....	38
<b>cleaning bodywork</b> .....	74
<b>cleaning up</b> .....	48
<b>cleaning wall, terrace or floor</b> .....	46
<b>cleaning water filter</b> .....	74
<b>contact details</b> .....	97
<b>customer service</b> .....	97

## D

<b>danger symbol</b> .....	31
<b>draining</b>	
during freezing temperatures .....	48

## E

<b>eco mode</b>	
ECO Start/Stop .....	67
Eco Stop .....	67
standard setting .....	65
switching off .....	65

## eControl+

colour lightbar .....	18
emergency stop .....	77
fault messages .....	77
navigation bullets .....	18
principle of operation .....	16
software version .....	68

## electronic water level control

### emergency stop

UrbanCombi, location .....	9
UrbanCombi, use .....	33

### enclosed spaces

working in .....	7
------------------	---

## ending the work

## F

### fault

prohibited to work during – .....	32
-----------------------------------	----

## filling water tank

### freezing temperatures

precautionary measures when ending the work .....	48
---	----

## H

### high pressure hose

handling .....	46
reeling in under pressure .....	45

### high pressure reel

freewheel lock .....	61
freewheel release .....	60

### high pressure valve

### hose counter

activating eControl+ .....	62
function .....	62
resetting .....	63
switching between metres and feet .....	63
switching off .....	62
switching on and off .....	62
things to keep in mind during use .....	62

## hose guide high pressure hose

## I

**increase or decrease speed** ..... 23

## L

**legionella**  
prevention of contamination ..... 48

**limit values** ..... 32

**lubricating moving parts** ..... 75

## M

**maintenance**  
before the work ..... 73  
major scheduled maintenance ..... 76  
safety instructions ..... 71

**maintenance interval**  
checking ..... 68

**maintenance schedule** ..... 71

**making changes to the machine** ..... 71

**management function eControl+**  
activating ..... 68  
function ..... 68

**manual**  
read and understand before use ..... 32

**maximum operating pressure** ..... 15

## O

**oil level too low** ..... 78

**open-end spanners** ..... 16

**operation standard functions** ..... 37

## P

**parts UrbanCombi** ..... 9

**personnel**  
operation by authorized personnel ..... 32

**poking the nozzle holes clean** ..... 74

**pressure gauge** ..... 75  
symbols ..... 15

**pressure regulator** ..... 34  
cleaning ..... 75  
symbols ..... 15

## prohibited

do not fasten levers and valves ..... 33

do not work in explosive environments ..... 32

substances which must not be sucked up ..... 32

**Protective covers** ..... 34

## protective equipment

personal ..... 33

## pulsator

manual operation ..... 51

purpose ..... 51

setting speed ..... 53

starting with eControl+ ..... 51

starting with remote control ..... 54

stopping with eControl+ ..... 52

stopping with remote ..... 54

## R

## reeling in/out

with eControl+ ..... 58

with remote control ..... 61

## reeling out

manually ..... 57

manually when controlled by eControl+ ..... 60

## remote control

5-channel ..... 27

7-channel ..... 28

9-channel ..... 29

battery replacement ..... 26

principle of operation ..... 23

**restrictions on use** ..... 32

**running dry** ..... 79, 80

## S

## safety

bystanders ..... 32

general ..... 31

## safety instructions

dangers of non-compliance with safety instructions ..... 31

**safety sticker** ..... 35

**securing** ..... 48

**sewer gases** ..... 33

**sewer unblocking** ..... 43



<b>spray gun</b>	
warnings .....	46
<b>spray nozzle</b>	
warning .....	43
<b>spraying</b>	
break .....	33
hazards .....	32
preparations .....	43, 46
starting .....	47
starting with machine .....	47
starting with remote control .....	44
stopping .....	45, 47
stopping with eControl+ .....	45
stopping with remote control .....	46
<b>starting engine</b>	
with eControl+ .....	40
with remote control .....	42
<b>swivel arm</b>	
latch .....	13
<b>T</b>	
<b>tachometer</b> .....	23
<b>technical specifications</b> .....	95

<b>temperature too high</b>	
Coolant .....	79
Engine .....	77
Heat exchanger .....	77
hydraulic oil .....	78
<b>thunderstorm</b>	
working during .....	32
<b>troubleshooting</b> .....	81
<b>type plate</b>	
location .....	93
<b>W</b>	
<b>water discharge</b> .....	34
<b>water level</b>	
too low .....	79, 80
<b>wear</b> .....	72
<b>wheel chock</b> .....	38
<b>working safely</b> .....	31
<b>workstation</b>	
preparations .....	38
<b>workstations and risks</b> .....	39



## 9 Attachments

## Annex 1 EC declaration of conformity

Rior, Industrie- en handelsonderneming B.V.  
declares that:

Brand: Rioned

Type: CityJet

Machine number:

- > is in conformity with the Machinery Directive (2006/42/EC);
- > complies with the provisions of the following other EC Directives: 2014/30/EC
- > complies with the harmonized European Standards:  
NEN-EN-ISO 12100:2010, NEN-EN-ISO 13850:2015,  
NEN-EN-ISO 13857, NEN-EN-349 and EN 60204-1

Declaration issued in Tilburg, The Netherlands, Monday 22 February 2016



J. Pieters  
Managing Director

## Annex 2 Type plate

The type plate is located at the left on the back side (relative to the driving direction) and shows the following information:

- A CE Marking
- B Manufacturer of the machine
- C European approval number (not yet available)
- D Chassis number of the vehicle
- E Identification of the machine
- F Manufacturer's address details
- G Year of manufacture of the machine
- H Name of the machine
- I Not applicable
- J Type high pressure pump
- K Length of high pressure hose (for which the nozzles were calculated)
- L Diameter, high pressure hose
- M Maximum machine capacity

<b>A</b>		<b>B</b>	<b>C</b>	<b>D</b>	<b>E</b>	<b>J</b>	<b>G</b>	<b>F</b>
<b>CE</b>	Fabrikant:	Rior, Industrie- en handelsonderneming B.V.			<b>Rioned</b>	Centaursweg 45 5015 TC Tilburg NEDERLAND Tel.: 013 - 5479100 Fax: 013 - 5479104		
	Goedkeuringsnr.:							
	VIN nr.:							
	Max. massa totaal:				Bouwjaar (m/j):			
	Max. druk as 1:	1-			Pomp			
	Max. druk as 2:	2-			Max. capaciteit:		Bar /	lpm
Type:	Max. koppeldruk:				HD-slang (l/dia):		m	Ø
<b>H</b>				<b>I</b>		<b>K</b>	<b>J</b>	<b>M</b>
							<b>L</b>	



## Annex 4 Technical specifications

### General

Capacity, water tank:	600 litres, 2 x 300 litres (expandable)
Length, high pressure hose:	60 - 100 m
Diameter, high pressure hose:	1/2" (NW13), 3/4" (NW19) or 5/8" (NW16)
Length, filling hose:	50 m
Diameter, filling hose:	3/4" NW19
Weight:	starting at 530 kg
Capacity, fuel tank:	30 litres

### Engine

Type:	Kubota V1505
Number of cylinders:	4
Bore x stroke (d x l):	78 x 78.4 mm
Cylinder displacement:	1498 cc
Power (P):	25 kW (34 hp) net intermittent 21.7 kW (29.5 hp) continuous power
Fuel:	Diesel
Cooling:	Water-cooled
Mass (m):	110 kg
Battery (U,I):	12 V, 45 A
Oil:	10W30 API/SF-CC or better (P/N 71002001030)

Type:	Kubota V1505 Turbo
Number of cylinders:	4
Bore x stroke (d x l):	78 x 78.4 mm
Cylinder displacement:	1498 cc
Power (P):	31.3 kW (42.6 hp) net intermittent 27.2 kW (37.0 hp) continuous power
Fuel:	Diesel
Cooling:	Water-cooled
Mass (m):	114 kg
Battery (U,I):	12 V, 45 A
Oil:	10W30 API/SF-CC or better (P/N 71002001030)

Normal engine coolant provides protection to -28 °C

Special engine coolant provides protection to -38 °C

Additional engine specifications can be found in the accompanying engine manual.

**High pressure pump**

Type:	Speck P45
Number of cylinders:	3
Number of valves:	6
Maximum capacity:	see type plate
Mass:	50 kg
Maximum water temperature:	60 °C
Oil type:	GX 80W90 (P/N 71002000090)
Volume:	3.5 l

Type:	Speck P52
Number of cylinders:	3
Number of valves:	6
Maximum capacity:	See type plate
Mass:	54 kg
Maximum water temperature:	60 °C
Oil type:	GX 80W90 (P/N 71002000090)
Volume:	3.5 l

**Oil tank, hydraulic system**

Volume:	approx. 5 l
Oil type:	Hydraulic oil HESTIA 46 (P/N 71003500046)



## Annex 5 Contact details

### **Rioned Customer Service**

Centaurusweg 45  
5015 TC Tilburg  
P.O. Box 5070  
NL-5004 EB Tilburg  
Tel. no.: +31 13-5479100  
E-mail: info@rioned.com  
Internet: www.rioned.com

### **AGENTS**

#### **South Netherlands**

Clément Thobie  
Mobile +31 6-46062830

#### **West Netherlands**

Ronald Groenewege  
Mobile +31 6-51145821

#### **Middle/North/East Netherlands**

Casper Mulderij  
Mobile +31 6-53 960 852

#### **Belgium**

Dominique Vink  
Sales & Business Development Manager Belgium  
+32 468 40 54 65

